

Room acoustic solutions from Rigips®

Perfect form and function

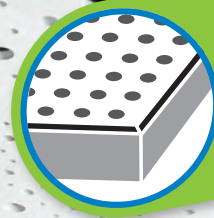

NEW!
Rigitone® - with
pre-sanded and
primed edge.



Contents

Product range Rigitone® Activ'Air®	4 – 5
Product range Rigitone® Climafit®	6
Functional and aesthetic living spaces	7
Room acoustic	8 – 25
Room acoustic – technical terms and parameters	10
Factors influencing absorption behavior	12
Standards for room acoustic planning	14
Optimum reverberation time – group A rooms	15
Optimum reverberation time – group B rooms	17
Positioning of acoustically effective surfaces	18
Group B rooms	22
Activ'Air® air cleaning power	26 – 29
Planning support	30 – 31
Room design for eyes and ears	32 – 33
Product range: Rigitone® Activ'Air® and Rigitone® Climafit®	34 – 61
Installation-information Rigitone® perforated ceilings	62 – 65
Rigitone® sports hall ceilings	66
Rigitone® F 30 ceiling: Fire protection and acoustic	67 – 69
Temperature control ceilings: Cooling and heating systems	70 – 73

Product range

Rigitone® Activ'Air®

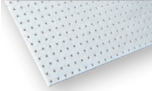
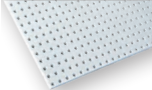
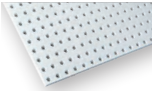
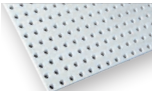
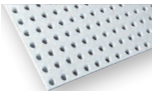
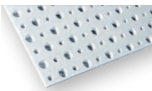

Rigitone® Activ'Air®

	Product name/ Page	Perforated area %	Hanger Spacing mm	Mineral-wool- edition ¹⁾ mm	Practical sound absorption coefficient α_p						α_w	sound absorber class
					125	250	500	1,000	2,000	4,000		
	Rigitone® Activ'Air® 6/18 R Page 36	8.7	30	30	0.30	0.50	0.60	0.55	0.50	0.55	0.55	D
			50		0.15	0.35	0.70	0.75	0.55	0.45	0.55	D
			50	50 (30+20)	0.45	0.60	0.60	0.55	0.50	0.55	0.55	D
			200		0.30	0.70	0.75	0.60	0.45	0.30	0.45 (LM)	D
			200	50 (30+20)	0.50	0.55	0.50	0.55	0.55	0.60	0.55	D
			400	50 (30+20)	0.50	0.50	0.55	0.60	0.55	0.60	0.60	C
	Rigitone® Activ'Air® 8/18 R Page 38	15.5	30	30	0.25	0.55	0.75	0.80	0.75	0.75	0.75	C
			50		0.15	0.30	0.65	0.85	0.60	0.45	0.55 (M)	D
			50	50 (30+20)	0.45	0.75	0.75	0.75	0.70	0.75	0.75	C
			200		0.40	0.60	0.80	0.60	0.50	0.50	0.60	C
			200	50 (30+20)	0.55	0.70	0.70	0.75	0.75	0.75	0.75	C
			400	50 (30+20)	0.60	0.60	0.70	0.80	0.75	0.75	0.75	C
	Rigitone® Activ'Air® 10/23 R Page 40	14.8	30	30	0.25	0.55	0.70	0.75	0.70	0.70	0.75	C
			50		0.10	0.25	0.65	0.90	0.55	0.25	0.45 (M)	D
			50	50 (30+20)	0.40	0.70	0.75	0.70	0.65	0.70	0.70	C
			200		0.35	0.70	0.85	0.60	0.50	0.35	0.50 (LM)	D
			200	50 (30+20)	0.60	0.75	0.70	0.70	0.70	0.75	0.70 (L)	C
			400	50 (30+20)	0.60	0.60	0.65	0.75	0.75	0.75	0.75	C
	Rigitone® Activ'Air® 12/25 R Page 44	18.1	30	30	0.20	0.55	0.80	0.85	0.80	0.75	0.80	B
			50		0.05	0.25	0.65	0.85	0.65	0.50	0.55 (M)	D
			50	50 (30+20)	0.40	0.75	0.80	0.80	0.75	0.75	0.80	B
			200		0.35	0.75	0.90	0.65	0.55	0.40	0.55 (LM)	D
			200	50 (30+20)	0.60	0.75	0.75	0.80	0.75	0.75	0.80	B
			400	50 (30+20)	0.70	0.65	0.75	0.85	0.80	0.75	0.80	B
	Rigitone® Activ'Air® 15/30 R Page 46	19.6	30	30	0.20	0.50	0.80	0.90	0.80	0.75	0.80	B
			50		0.10	0.25	0.60	0.85	0.55	0.30	0.45 (M)	D
			50	50 (30+20)	0.40	0.75	0.85	0.85	0.75	0.80	0.85	B
			200		0.35	0.70	0.85	0.60	0.50	0.35	0.50 (LM)	D
			200	50 (30+20)	0.60	0.80	0.80	0.80	0.80	0.70	0.80	B
			400	50 (30+20)	0.70	0.70	0.75	0.90	0.85	0.75	0.85	B
	Rigitone® Activ'Air® 12-20/66 R Page 48	19.6	30	30	0.20	0.55	0.80	0.95	0.80	0.75	0.80	B
			50		0.10	0.25	0.60	0.85	0.55	0.30	0.45 (M)	D
			50	50 (30+20)	0.40	0.75	0.85	0.90	0.70	0.75	0.80	B
			200		0.40	0.70	0.85	0.60	0.50	0.35	0.50 (LM)	D
			200	50 (30+20)	0.65	0.80	0.80	0.85	0.75	0.75	0.80	B
			400	50 (30+20)	0.70	0.70	0.75	0.90	0.80	0.75	0.80	B

¹⁾ for example Isover Akustic SSP 1 or Ultimate TP-039

Rigitone® Activ'Air®

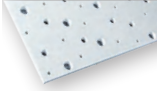
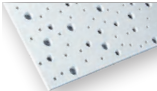
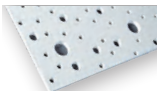
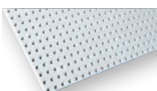
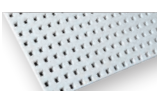
	Product name/ Page	Per- forated area %	Hanger Spac- ing mm	Mineral- wool- edition ¹⁾ mm	Practical sound absorption coefficient α_p						α_w	sound absorber class
					125	250	500	1,000	2,000	4,000		
	Rigitone® Activ'Air® 8-15-20 R Page 50	6.0	30	30	0.30	0.50	0.50	0.45	0.35	0.35	0.45	D
			50		0.10	0.40	0.65	0.55	0.25	0.10	0.25 (LM)	E
			50	50 (30+20)	0.50	0.50	0.45	0.40	0.30	0.35	0.40 (L)	D
			200		0.40	0.70	0.65	0.40	0.25	0.15	0.30 (LM)	D
			200	50 (30+20)	0.45	0.50	0.45	0.45	0.35	0.35	0.45	D
			400	50 (30+20)	0.45	0.40	0.45	0.45	0.40	0.40	0.45	D
	Rigitone® Activ'Air® 8-15-20 super R Page 52	10.0	30	30	0.25	0.55	0.65	0.65	0.50	0.50	0.60	C
			50		0.15	0.40	0.70	0.75	0.45	0.40	0.50 (M)	D
			50	50 (30+20)	0.45	0.60	0.60	0.60	0.45	0.55	0.55	D
			200		0.35	0.75	0.75	0.55	0.40	0.30	0.45 (LM)	D
			200	50 (30+20)	0.55	0.65	0.60	0.60	0.55	0.55	0.60	C
			400	50 (30+20)	0.55	0.60	0.60	0.65	0.60	0.70	0.65	C
	Rigitone® Activ'Air® 12-20-35 R Page 54	11.0	30	30	0.25	0.55	0.70	0.65	0.50	0.45	0.55	D
			50		0.20	0.30	0.60	0.70	0.45	0.30	0.45	D
			50	50 (30+20)	0.45	0.70	0.65	0.60	0.45	0.45	0.55 (L)	D
			200		0.35	0.55	0.70	0.50	0.40	0.30	0.45 (L)	D
			200	50 (30+20)	0.55	0.65	0.70	0.55	0.45	0.45	0.55 (L)	D
			400	50 (30+20)	0.55	0.55	0.65	0.60	0.50	0.45	0.55	D
	Rigitone® Activ'Air® 8/18 Q Page 58	19.8	30	30	0.20	0.55	0.75	0.85	0.80	0.85	0.80	B
			50		0.15	0.25	0.60	0.85	0.65	0.50	0.55 (M)	D
			50	50 (30+20)	0.40	0.70	0.80	0.80	0.75	0.80	0.80	B
			200		0.40	0.65	0.80	0.60	0.55	0.50	0.60	C
			200	50 (30+20)	0.60	0.75	0.75	0.80	0.80	0.80	0.80	B
			400	50 (30+20)	0.65	0.60	0.70	0.85	0.85	0.85	0.80	B
	Rigitone® Activ'Air® 12/25 Q Page 60	23.0	30	30	0.20	0.55	0.80	0.95	0.90	0.80	0.80	B
			50		0.10	0.30	0.65	0.90	0.80	0.60	0.60 (M)	C
			50	50 (30+20)	0.35	0.75	0.90	0.90	0.80	0.80	0.90	A
			200		0.35	0.75	0.90	0.70	0.65	0.50	0.65 (LM)	C
			200	50 (30+20)	0.70	0.85	0.85	0.90	0.85	0.90	0.90	A
			400	50 (30+20)	0.70	0.75	0.80	0.95	0.90	0.95	0.90	A

¹⁾ for example Isover Akustic SSP 1 or Ultimate TP-039

Product range

Rigitone® Climafit®

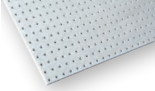
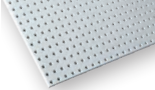
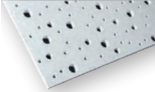
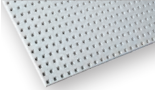
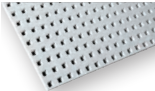
Rigitone® Climafit®												
	Product name/ Page	Perforated area %	Hanger Spacing mm	Mineral-wool- edition ¹⁾ mm	Practical sound absorption coefficient α_p						α_w	sound absorber class
					125	250	500	1,000	2,000	4,000		
	Rigitone® Climafit® 6/18 R Page 36	8.7	30	30	0.30	0.50	0.60	0.55	0.50	0.55	0.55	D
			50		0.15	0.35	0.70	0.75	0.55	0.45	0.55	D
			50	50 (30+20)	0.45	0.60	0.60	0.55	0.50	0.55	0.55	D
			200		0.30	0.70	0.75	0.60	0.45	0.30	0.45 (LM)	D
			200	50 (30+20)	0.50	0.55	0.50	0.55	0.55	0.60	0.55	D
			400	50 (30+20)	0.50	0.50	0.55	0.60	0.55	0.60	0.60	C
	Rigitone® Climafit® 8/18 R Page 38	15.5	30	30	0.25	0.55	0.75	0.80	0.75	0.75	0.75	C
			50		0.15	0.30	0.65	0.85	0.60	0.45	0.55 (M)	D
			50	50 (30+20)	0.45	0.75	0.75	0.75	0.70	0.75	0.75	C
			200		0.40	0.60	0.80	0.60	0.50	0.50	0.60	C
			200	50 (30+20)	0.55	0.70	0.70	0.75	0.75	0.75	0.75	C
			400	50 (30+20)	0.60	0.60	0.70	0.80	0.75	0.75	0.75	C
	Rigitone® Climafit® 8-15-20 super R Page 52	10.0	30	30	0.25	0.55	0.65	0.65	0.50	0.50	0.60	C
			50		0.15	0.40	0.70	0.75	0.45	0.40	0.50 (M)	D
			50	50 (30+20)	0.45	0.60	0.60	0.60	0.45	0.55	0.55	D
			200		0.35	0.75	0.75	0.55	0.40	0.30	0.45 (LM)	D
			200	50 (30+20)	0.55	0.65	0.60	0.60	0.55	0.55	0.60	C
			400	50 (30+20)	0.55	0.60	0.60	0.65	0.60	0.70	0.65	C
	Rigitone® Climafit® 8/18 Q Page 58	19.8	30	30	0.20	0.55	0.75	0.85	0.80	0.85	0.80	B
			50		0.15	0.25	0.60	0.85	0.65	0.50	0.55 (M)	D
			50	50 (30+20)	0.40	0.70	0.80	0.80	0.75	0.80	0.80	B
			200		0.40	0.65	0.80	0.60	0.55	0.50	0.60	C
			200	50 (30+20)	0.60	0.75	0.75	0.80	0.80	0.80	0.80	B
			400	50 (30+20)	0.65	0.60	0.70	0.85	0.85	0.85	0.80	B
	Rigitone® Climafit® 12/25 Q Page 60	23.0	30	30	0.20	0.55	0.80	0.95	0.90	0.80	0.80	B
			50		0.10	0.30	0.65	0.90	0.80	0.60	0.60 (M)	C
			50	50 (30+20)	0.35	0.75	0.90	0.90	0.80	0.80	0.90	A
			200		0.35	0.75	0.90	0.70	0.65	0.50	0.65 (LM)	C
			200	50 (30+20)	0.70	0.85	0.85	0.90	0.85	0.90	0.90	A
			400	50 (30+20)	0.70	0.75	0.80	0.95	0.90	0.95	0.90	A

¹⁾ for example Isover Akustic SSP 1 or Ultimate TP-039

Functional and aesthetic living spaces

The modern acoustic systems from Rigips offer optimum solutions for acoustic ceilings and walls which perform two key functions. On the one hand, the broad spectrum of acoustic boards offers virtually unlimited design scope for creating highly attractive rooms and buildings. On the other hand, the acoustic properties of the boards are ideal for planning and designing optimum room acoustic. Rigips acoustic systems meet the most demanding requirements in terms of material properties, variety of shapes and acoustic results.

The Rigips acoustic ceiling range combines functionality and aesthetics in the modern design of walls and ceilings. Integrating lighting, ventilation systems, loudspeakers, etc. is straightforward and simple.

Rigips acoustic boards also have a long lifetime and can be renovated at any time without altering the acoustic properties of the ceilings. In addition, they have a positive effect on room climate as they absorb and release moisture, as well as removing pollutants from room air.

Rigips acoustic solutions meet the many requirements of modern construction equally - aesthetics, individuality, eco-friendliness, safety and long lifetime.

Gain an insight into the variety of aesthetic and functional living spaces which can be created.



The term “room acoustic” describes the propagation of sound in a room and is one of its key quality and comfort features. Many people suffer from the effects of poor room acoustic, which are often linked to the reverberance in the room.

Poor room acoustic quickly lead to fatigue or an inability to retain information from important texts. In other words, a person’s performance levels are severely impacted in rooms with unfavourable acoustic.

The oldest and most well-known criterion for room acoustic is reverberation time. Reverberation time expresses in numbers the length of time a sound lingers in a room after the source of the sound has been silenced. The longer the reverberation time, the longer the sound can be heard in the room – the room echoes. If it is too short, the room is excessively insulated and we cannot hear the sound clearly enough.

The reverberation time of a room is largely influenced by its geometric design, and the selection and positioning of sound-absorbing and sound-reflecting surfaces.

The acoustic design of rooms is regulated in various standards, specifications and guidelines. The most important set of regulations is the DIN 18041 standard “Acoustic quality in small and medium-sized rooms”. In addition to requirements and recommendations relating to reverberation time – depending on room use – this standard includes information on acoustic room design.

Sound absorption

Sound absorption describes the removal of sound energy from a room or section of a room by converting it into another form of energy (e.g. heat: "dissipation"). Sound absorption is the most important tool in acoustic room design. Absorbing and reflecting surfaces determine the acoustic properties of a room.

Strictly speaking, there is no such thing as "good" or "poor" absorption - this is why no standardized absorption requirements have been defined for individual surfaces. The total amount of absorption required is determined by the structural properties, fittings and planned use of the room.

Sound absorption coefficients α and α_s

The sound absorption coefficient defines the ratio of the sound energy not reflected from α surface to the incident sound energy:

- Full sound reflection: $\alpha = 0$
- Full sound absorption: $\alpha = 1$.

The sound absorption coefficient α is the frequency-dependent value of the sound absorption capacity of a material. α_s is measured in third octave bands by means of acoustic testing in a reverberation chamber in accordance with DIN EN ISO 354.

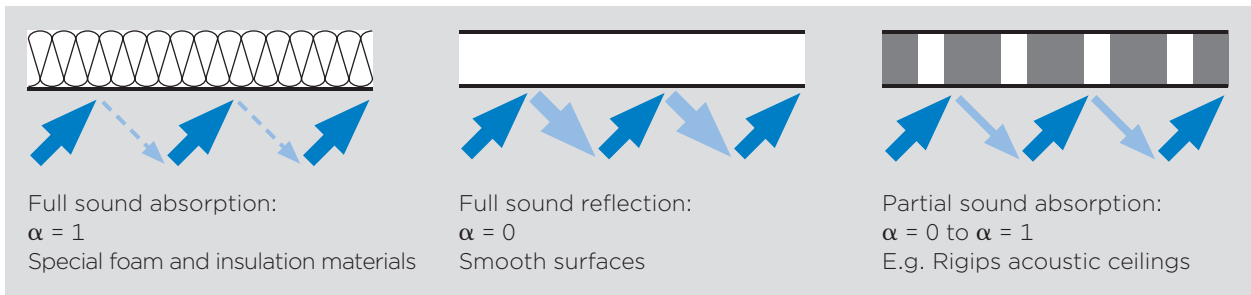

Practical sound absorption coefficient α_p

The practical sound absorption coefficient α_p is the frequency-dependent value of the absorption capacity in octave bands. The α_p is determined by converting the α_s values to octave bands in accordance with DIN EN ISO 11654:

$$\text{Example for 250 Hz: } \alpha_{p250} = \frac{\alpha_{s200} + \alpha_{s250} + \alpha_{s315}}{3}$$

The practical sound absorption coefficient α_p is rounded in 0.05 (5%) increments to a maximum of 1.00.



Room acoustic – technical terms and parameters

Rated sound absorption coefficient α_w

The rated sound absorption coefficient α_w is a frequency-independent single value for the sound absorption capacity of a material and is calculated in accordance with DIN EN ISO 11654. The α_w is determined by laying a reference curve over the α_p values and shifting it until the total negative deviation is ≤ 0.1 . The rated sound absorption coefficient α_w corresponds to the value of the shifted reference curve at 500 Hz.

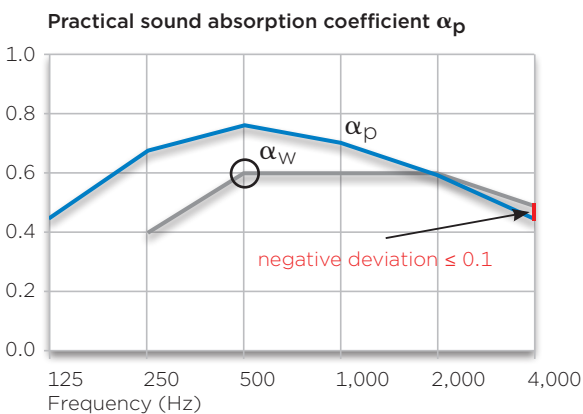

If the practical sound absorption coefficient α_{pi} exceeds the reference curve value by ≥ 0.25 , one or more shape indicators must be used in addition to the α_w value:

- (L) = exceeds at 250 Hz
- (M) = exceeds at 500 or 1,000 Hz
- (H) = exceeds at 2,000 or 4,000 Hz

Example (250 Hz):

$$0.65 - 0.40 = 0.25 (\geq 0.25) = (L) \rightarrow \alpha_w = 0.60 (L)$$

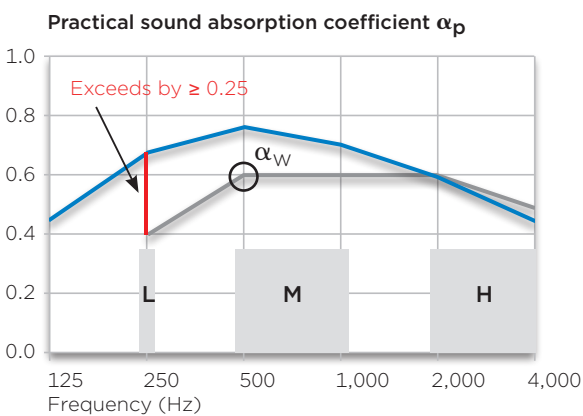

! Rigips Note!

If the rated sound absorption coefficient α_w is given together with one or two shape indicators, the complete sound absorption curve should be applied to obtain a value.

Sound absorber classes

The rated sound absorption coefficient α_w can be used to determine the sound absorber class in accordance with DIN EN ISO 11654:

Sound absorber class	Rated sound absorption coefficient α_w
A	0.90; 0.95; 1.00
B	0.80; 0.85
C	0.60; 0.65; 0.70; 0.75
D	0.30; 0.35; 0.40; 0.45; 0.50; 0.55
E	0.25; 0.20; 0.15
Not classified	0.10; 0.05; 0.00

Diagram showing the sound absorber classes

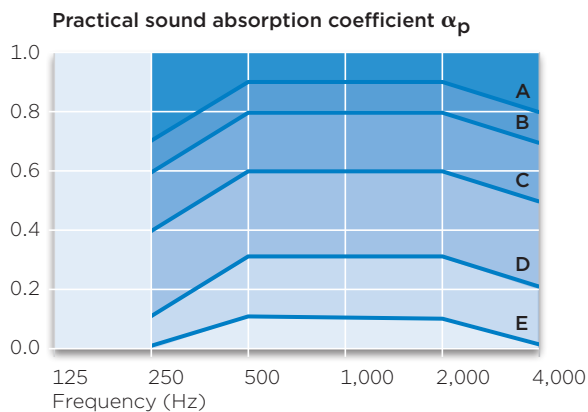

Equivalent sound absorption area

Multiply the absorption coefficient (α) of a material by its surface (S) to obtain the equivalent sound absorption area (A):

$$A = \alpha \cdot S \text{ [m}^2\text{]}.$$

Reverberation time T

The reverberation time is the time in seconds required for the sound pressure level to fade by 60 dB after the source of the sound has been silenced.

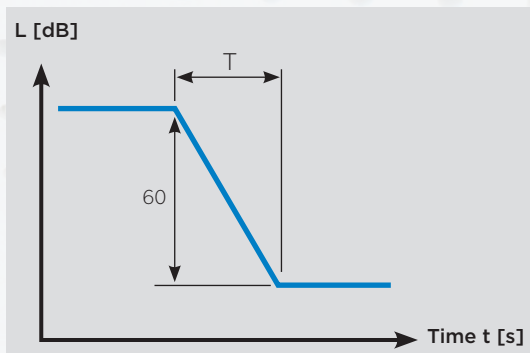

The reverberation time can be calculated for the majority of room situations using the "Sabine formula":

$$T = 0.163 \cdot \frac{V}{A}$$

T = reverberation time [s]

V = room volume [m³]

A = equivalent sound absorption area [m²]

Factors influencing absorption behaviour

The wide range of Rigitone acoustic ceilings can meet virtually all acoustic requirements. The sound-absorbing properties of Rigitone acoustic ceilings are influenced by the following factors:

Perforated area/hole shape

The perforation pattern selected usually also has an influence on the acoustic properties of the ceiling structure. For example, an increase in the perforated area usually increases the level of sound absorption.

However, any changes in value are minimal where the perforated area exceeds 25%.

Plenum depth/air cavity

In addition to the perforation pattern, the plenum depth - the distance between the slab and the top edge of the acoustic ceiling - also has a decisive influence on the acoustic properties of the ceiling.

At low plenum depths < 100 mm, the sound absorption curve shifts towards the medium- and high-frequency range (to the right). Increasing the plenum depth will in turn increase the sound absorption in the low-frequency range. This effect is lost at plenum depths ≥ 500 mm.

Practical sound absorption coefficient α_p

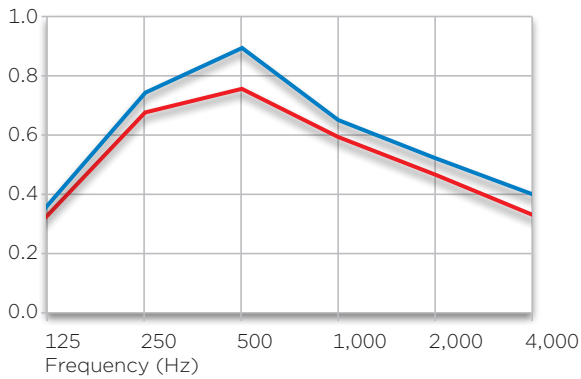

- Example showing a perforated area of 8.7%
- Example showing a perforated area of 18.1%

Practical sound absorption coefficient α_p

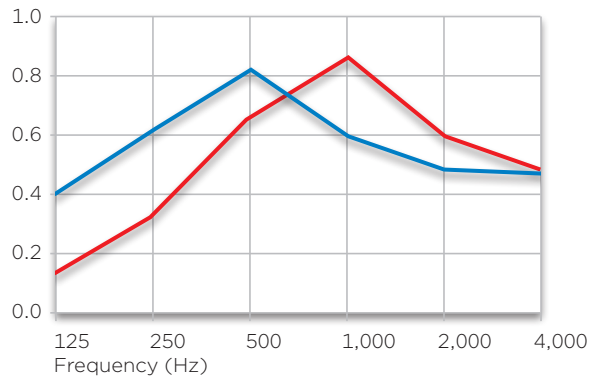

- Plenum depth of 50 mm
- Plenum depth of 200 mm



Rigitone Activ'Air 8-15-20 super R

Acoustic tissue

All Rigitone acoustic ceiling systems are fitted with acoustic tissue on the reverse as standard, ensuring optimum acoustic in virtually all rooms in which noise is primarily caused by people's voices, e.g. offices, schools, kindergartens, lecture halls and assembly rooms.

Mineral wool layer

A mineral wool layer increases sound absorption - in particular in the deep-frequency range. Ceiling structures with a low plenum depth and wall absorbers should therefore always be fitted with a mineral wool layer.

Example: Rigitone® Activ'Air® 8/18 R

Practical sound absorption coefficient α_p

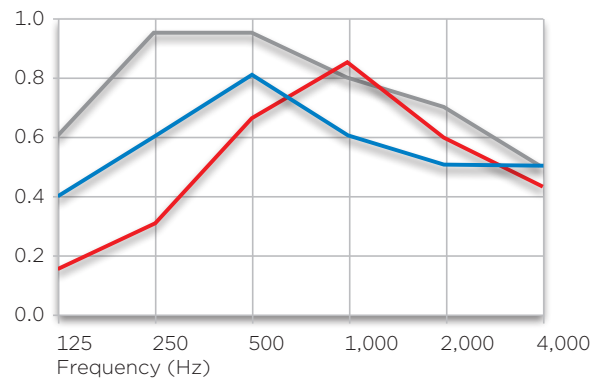

- Plenum depth 50 mm
- Plenum depth 200 mm
- Plenum depth 200 mm, mineral wool layer 50 mm

Wall absorbers

In order to further improve room acoustic, supplementary absorber surfaces can be added to bordering wall surfaces. To ensure optimum sound absorption across the entire frequency range in this instance, the following points should be observed

- A perforated board with the largest possible perforated area and an acoustic tissue should be used
- A mineral wool layer should be included



Standards for room acoustic planning

Standards for room acoustic planning Requirements, recommendations and advice for planning

Various regulations exist for the acoustic design of rooms. The following information is related to the German standard DIN 18041 and serves as a guidance. Specific national regulations must be taken into account in other countries. DIN 18041 applies to rooms with a room volume of up to about 5.000 m³, for sports and swimming halls up to 30.000 m³. It specifies the room acoustic requirements, recommendations and planning guidelines for ensuring audibility, primarily for speech communication, including the necessary measures.

The audibility of a room is mainly influenced by the geometrical design of the room, the selection and distribution of sound absorbing and sound reflecting surfaces, the reverberation time and the total interference sound pressure level.

The standard distinguishes two applications:

Group A - medium and long distances

e.g. classrooms in schools, group rooms in day-care facilities, conference rooms, courtrooms and council chambers, seminar rooms, lecture halls, sports halls and swimming pools. Adequate reverberation time and sound reduction ensure audibility.

Group B - short distances

such as traffic areas with recreational quality, dining rooms, canteens, play areas and changing rooms in schools and day-care facilities, exhibition rooms, entrance halls, counter halls, offices.

The audibility is achieved by sound absorption and noise reduction.

Optimum reverberation time – group A rooms

Group A rooms

The basis for good audibility in room group A is the acoustically coordinated interaction of room geometry, size and equipment as well as the overall noise pressure level.

Types of use

The reverberation time requirements for good audibility depend on the room volume and the type of use of the room. For rooms in group A, a distinction is made between the following types of use:

A1: "music";

A2: "speech/lecture";

A3: "teaching/communication" and "speech/lecture included";

A4: "Instruction/communication included";

A5: "sport".

The target values of the reverberation time T_{target} for the five types of use A1 to A5 are calculated according to equations (1) to (6) as a function of the volume V . The target values of the reverberation time must be given mathematically rounded to two decimal places.

A1 music:

$$T_{\text{target A1}} = \left(0.45 \lg \frac{V}{\text{m}^3} + 0.07 \right) \text{ s} \quad 30 \text{ m}^3 \leq V < 1,000 \text{ m}^3$$

A2 speech / lecture:

$$T_{\text{target A2}} = \left(0.37 \lg \frac{V}{\text{m}^3} - 0.14 \right) \text{ s} \quad 50 \text{ m}^3 \leq V < 5,000 \text{ m}^3$$

A3 teaching / communication (up to 1,000 m³) and speech / lecture included (up to 5,000 m³)

$$T_{\text{target A3}} = \left(0.32 \lg \frac{V}{\text{m}^3} - 0.17 \right) \text{ s} \quad 30 \text{ m}^3 \leq V < 5,000 \text{ m}^3$$

A4 Instruction / communication included:

$$T_{\text{target A4}} = \left(0.26 \lg \frac{V}{\text{m}^3} - 0.14 \right) \text{ s} \quad 30 \text{ m}^3 \leq V < 500 \text{ m}^3$$

A5 sport:

$$T_{\text{target A5}} = \left(0.75 \lg \frac{V}{\text{m}^3} - 1.00 \right) \text{ s} \quad 200 \text{ m}^3 \leq V < 10,000 \text{ m}^3$$

$$T_{\text{target A5}} = 2.0 \text{ s} \quad V \geq 10,000 \text{ m}^3$$

Optimum reverberation time - group A rooms

The dependence of the target reverberation time T_{target} on the room volume V is shown in the following diagram. For untypical room volumes in the sense of this standard, the setpoint range is dotted in the diagram

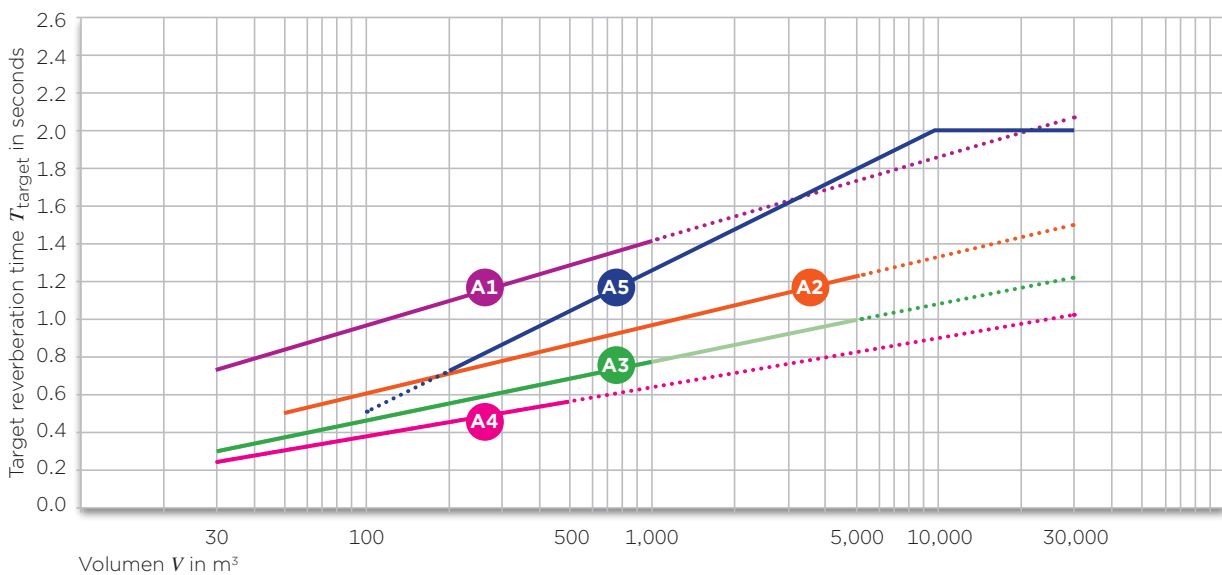

T_{target} Target reverberation time in seconds
 V Volume in cubic metres

— Target reverberation time as a function of the room volume for the purposes of this standard typical room volumes in seconds
 — Target reverberation time as a function of room volume in seconds
 Target reverberation time as a function of the room volume for the purposes of this standard untypical room volumes

A1 Type of use: music
A2 Type of use: language / lecture
A3 Type of use: teaching / communication (up to 1.000 m^3) and language / lecture included (up to 5.000 m^3)
A4 Type of use: teaching / communication included
A5 Type of use: sport

Optimum reverberation time - group B rooms

The tolerance range of the frequency-dependent reverberation time T is shown in the following diagram for the usage types A1 to A4. A1 bis A4 gezeigt.

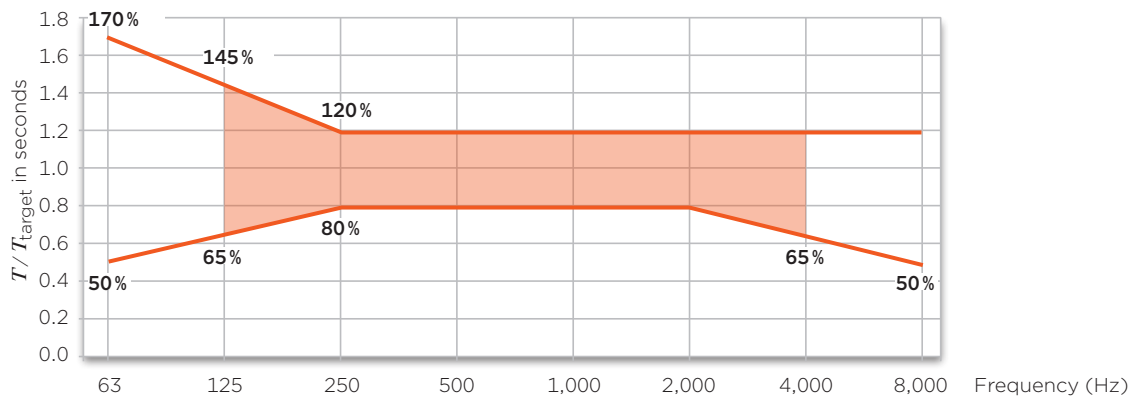

T/T_{target} Frequency-dependent reverberation time T related to the target reverberation time T_{target}
 f Frequency in Hertz

For type of use A5, the reference value $T_{\text{target A5}}$ determined according to the equation must be maintained between 250 Hz and 2.000 Hz with an accuracy of $T_{\text{target A5}} \pm 20\%$. In the case of divisible sports halls, the requirements must be verified for both the undivided hall and the hall sections.

Calculations also under: rigips.de/services/rechenservice/raumakustik-rechner



Positioning of acoustically effective surfaces

In principle, it is desirable that the absorbing surfaces and elements are evenly on the room surfaces or in the room. It is advisable to use the values in examples A, B, D, E and F. The example C shows unfavourable absorber distributions. The size of the sound absorbing surfaces must be calculated according to DIN 18041. Sound absorbers with preferential effectiveness in the low-frequency range are particularly effective near the sound source, at room corners or edges.

Distribution of sound absorption surfaces for rooms of small to medium size, e.g. classrooms and conference rooms (top view, soffit below)

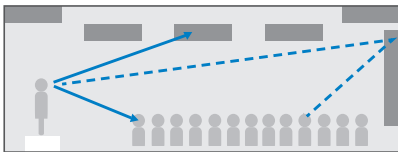

Side view

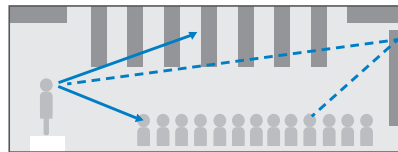

Side view

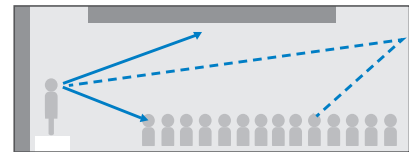

Side view



Example A: favorable



Example B: favorable



Example C: unfavorable

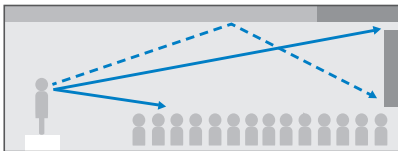

Side view

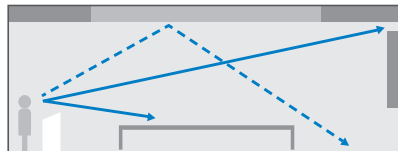

Side view

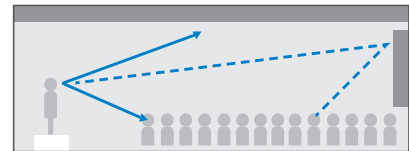

Side view



Example D: favorable



Example E: favorable



Example F: favorable



Reflections on the rear wall

In rooms with a length of more than about 9 m, sound components can be directed from the rear wall into the front of the room, either directly or via angled mirror reflections with a long delay, which leads to a reduction in speech intelligibility. In this case, these reflective surfaces must either be clad sound-absorbing or tilted so that the incident sound is reflected as useful amplification towards the listeners further away from the sound source (see examples A and B shown below). Even highly structured sound-scattering surfaces (e.g. bookshelves) are useful

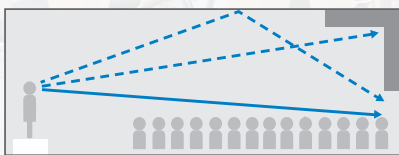

Example A: favorable

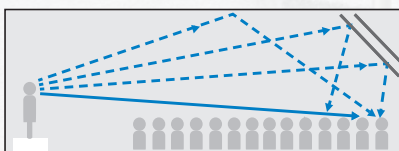

Example B: favorable

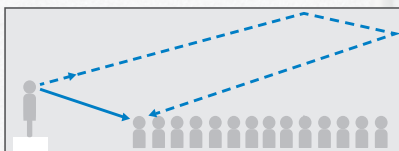

Example C: unfavorable



Positioning of acoustically effective surfaces

Parallel walls

If the surfaces are parallel to each other, at least one of the opposite surfaces should be structured or sound-absorbing (examples A and B). This is especially true for larger rooms with non-rising seating. It is also advisable to incline the surfaces by at least about 5°.

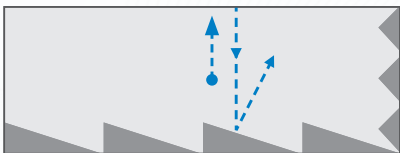

Example A: favorable



Example B: favorable



Example C: unfavorable



Useful reflections for the back of the room

In order to amplify useful sound at greater distances and thus achieve improved speech intelligibility, the appropriate arrangement and orientation reflective surfaces are necessary.

The wall behind the speaker and the central part of the ceiling from which the first reflections reach the listeners should be sound-reflecting in the medium and high frequency range and designed as a depth absorber.

If the ceiling or side wall surfaces are not flat, but rather structured over a large area, the individual elements should be aligned so that the sound is directed into the middle and rear audience areas (see illustrations).

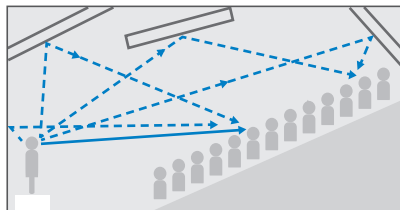

Example A (section)

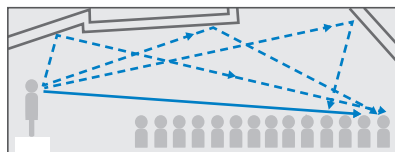

Example B (section)

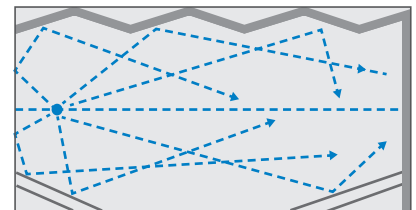

Example C (ground plan)

Group B rooms

Group B rooms

For rooms in room group B, measures for room soundproofing are recommended. This reduces the average background noise level in the room and limits the reverberation.

Types of use

The rooms in group B must be assigned to one of the five types of use B1 to B5 (the table describes the respective types of use and gives examples of corresponding rooms). Comparable rooms should be classified accordingly. For rooms with multiple uses or types of use, e.g. a waiting area in a hospital with a counter area with a permanent workplace, the higher recommendation for the A/V ratio must be taken into account.

Types of use with description and examples for rooms in group B		
Types of use	Description	Examples
B1	Rooms without quality of stay	Entrance halls, corridors, staircases, etc. as pure Traffic areas (excluding traffic areas in schools, day-care centres, hospitals and nursing homes)
B2	Rooms for short-term stay	Entrance halls, corridors, staircases, etc. Traffic areas with a recreational quality (reception area with waiting areas etc.), exhibition rooms, counter halls, changing rooms in sports halls
B3	Rooms for long-term stay	Exhibition rooms with interactivity or increased noise levels (multi-media, sound / video art, etc.), circulation areas in schools and day-care facilities (kindergarten, crèche, after-school care, etc.), circulation areas with quality of stay in hospitals and care facilities (e.g. open waiting areas), patient rooms, break rooms, bed rooms, rest rooms, operating theatres, treatment rooms, examination rooms, consulting rooms, dining rooms, canteens, laboratories, libraries, sales rooms with quality of stay
B4	Rooms in need of noise reduction and room comfort	Reception / counter area with permanent workplace, laboratories with permanent workplace, lending areas of libraries, issuing areas in canteens, residents' rooms in nursing homes, citizens' office, office rooms a,b ^{a, b}
B5	Rooms with a special need for noise reduction and room comfort	Dining rooms and canteens in schools, day-care facilities for children (kindergarten, crèche, after-school care etc.), hospitals and nursing homes, work rooms with particularly high noise levels (e.g. workshops, workshops, canteen kitchens, sculleries), call centres a, control centres, security centres, intensive care areas, guard stations, exercise rooms in day-care facilities, play corridors and changing rooms in schools and day-care facilities (kindergarten, crèche, after-school care etc.)

^a Recommendations for offices and call centres are dealt with in detail in the guideline VDI 2569

^b Individual offices can be classified under usage type B3

Orientation values for the ratio of the equivalent sound absorption area of a room and the room volume (A/V)

The guide values given in the table below for the minimum required A/V ratio apply in the individual octaves from 250 Hz to 2,000 Hz without taking sound absorption by persons into account and are specified as a function of the clear room height h .

In multi-storey rooms (e.g. atria with connected arcades), h refers to the total room height. However, a floor-by-floor view leads to a larger absorption area and is therefore advantageous with regard to sound level reduction. The average clear room height h can be calculated by dividing the room volume by the net floor area of the room.

Orientation values for the ratio of equivalent sound absorption area A to room volume V		
Type of use	for room heights $h \leq 2.5$ m m^2/m^3	for room heights $h > 2.5$ m m^2/m^3
B1	without requirement	without requirement
B2	$A/V \geq 0.15$	$A/V \geq [4.80 + 4.69 \lg (h/1 \text{ m})]^{-1}$ (7)
B3	$A/V \geq 0.20$	$A/V \geq [3.13 + 4.69 \lg (h/1 \text{ m})]^{-1}$ (8)
B4	$A/V \geq 0.25$	$A/V \geq [2.13 + 4.69 \lg (h/1 \text{ m})]^{-1}$ (9)
B5	$A/V \geq 0.30$	$A/V \geq [1.47 + 4.69 \lg (h/1 \text{ m})]^{-1}$ (10)

This includes

A : the equivalent sound absorption area of a room in square metres

V : the room volume in cubic metres

h : the clear room height in metres

Further information can be found in DIN 18041

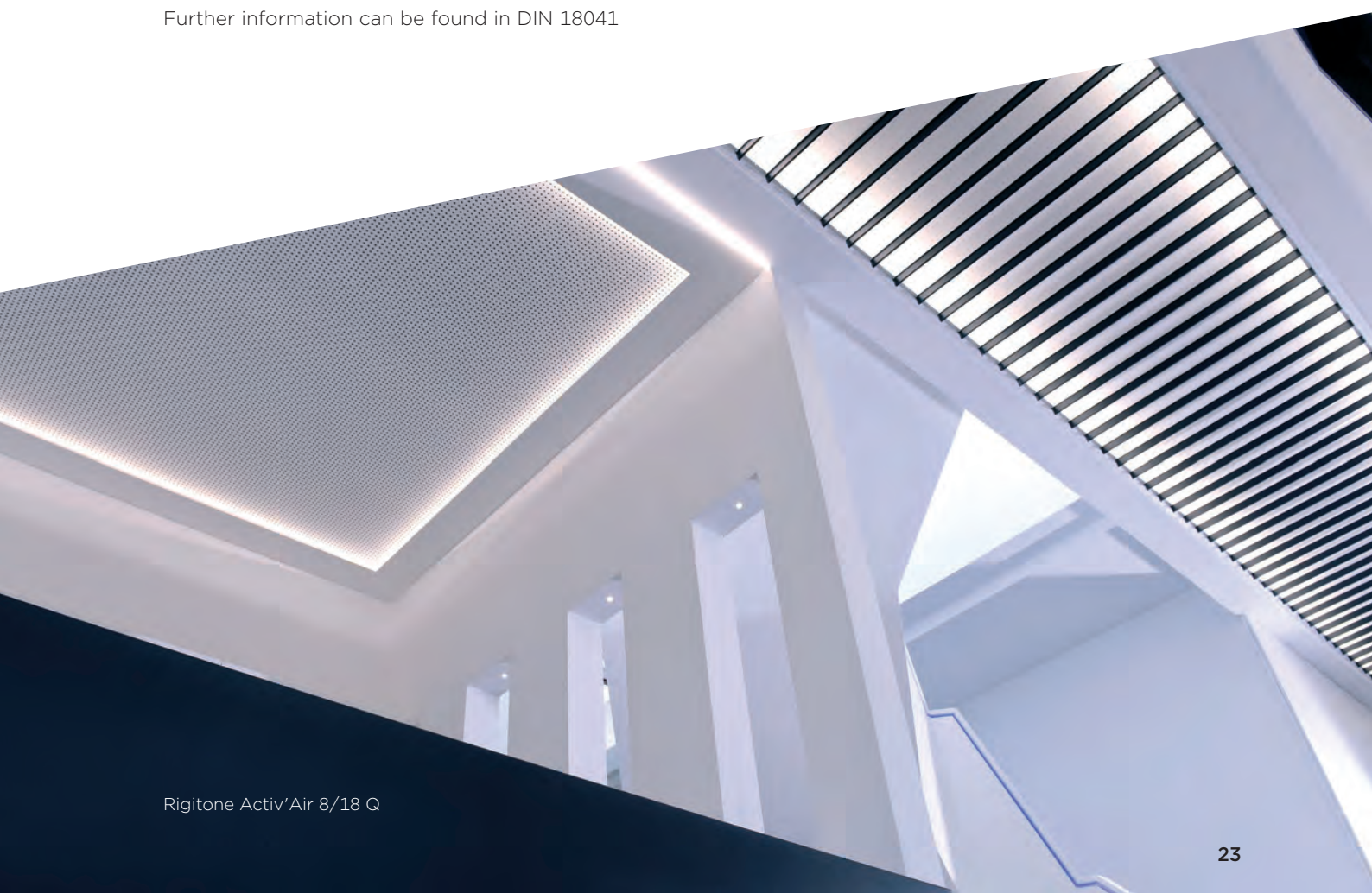

References





Activ'Air® air cleaning power

Rigitone® Activ'Air®: Good room acoustic, healthy room climate, great design

Good room acoustic and healthy air are critically important for people's wellbeing. All the more so when you consider that we spend up to 90% of our time in enclosed spaces – whether at home, in the office, at kindergarten or school, in auditoriums or leisure facilities such as sports clubs.

While we can clearly perceive good and bad room acoustic, we are often exposed to invisible pollutants, e.g. through vapours from carpets and other floor coverings, paints or adhesives, without realising it. Air pollutants such as volatile organic compounds (VOCs) can impact our wellbeing and significantly damage our health.

60% less formaldehyde

Such VOCs, in particular formaldehyde, can be immediately – and most importantly – permanently removed from room air by the new Rigitone Activ'Air acoustic boards. Thanks to their unique active agent, Rigitone Activ'Air boards can permanently reduce formaldehyde by 60%. A lasting effect which consistently ensures very good room air and thus greater wellbeing. And last but not least, the attractive perforation design makes them real eye-catchers. Wherever they are installed.



Room-Clima

- ✓ Permanently removes 60% of formaldehyde from room air



Design freedom

- ✓ Jointless ceiling appearance
- ✓ Wide range of ceiling designs with different perforations



Silence

- ✓ Excellent room acoustic properties



Sustainability

- ✓ Reduction in pollutants with no re-emission

How does Activ’Air® work?

Rigitone Activ’Air boards contain a unique organic mineral substance. It can absorb formaldehyde from room air, convert it into harmless, inactive compounds and permanently bind them in its structure. This ensures a sustainable reduction in formaldehyde without any risk of re-emission.

Proven long-term effect

Rigitone Activ’Air is an innovative material with proven performance you can rely on. In a long-term test conducted in accordance with international standards, it was proven that the installation of Rigitone Activ’Air permanently removes 60% of formaldehyde from room air after just a short time and without any risk of re-emission. An important contribution to healthy construction which offers greater living comfort and has a long-term positive effect on people’s wellbeing. Current simulation calculations also prove that Activ’Air boards remain effective for at least 50 years.

Through the circulation of air in the room formaldehyde comes into contact with the board, which converts the harmful substances into inert compounds:

- 1. Activ’Air absorbs formaldehyde from the room air.

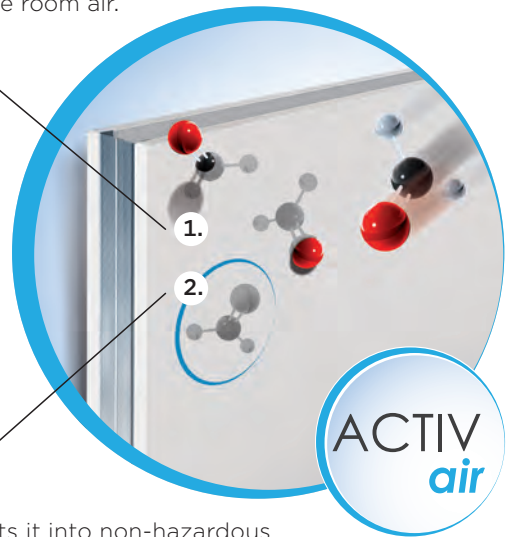

- 2. Converts it into non-hazardous substances and permanently binds it in the board.

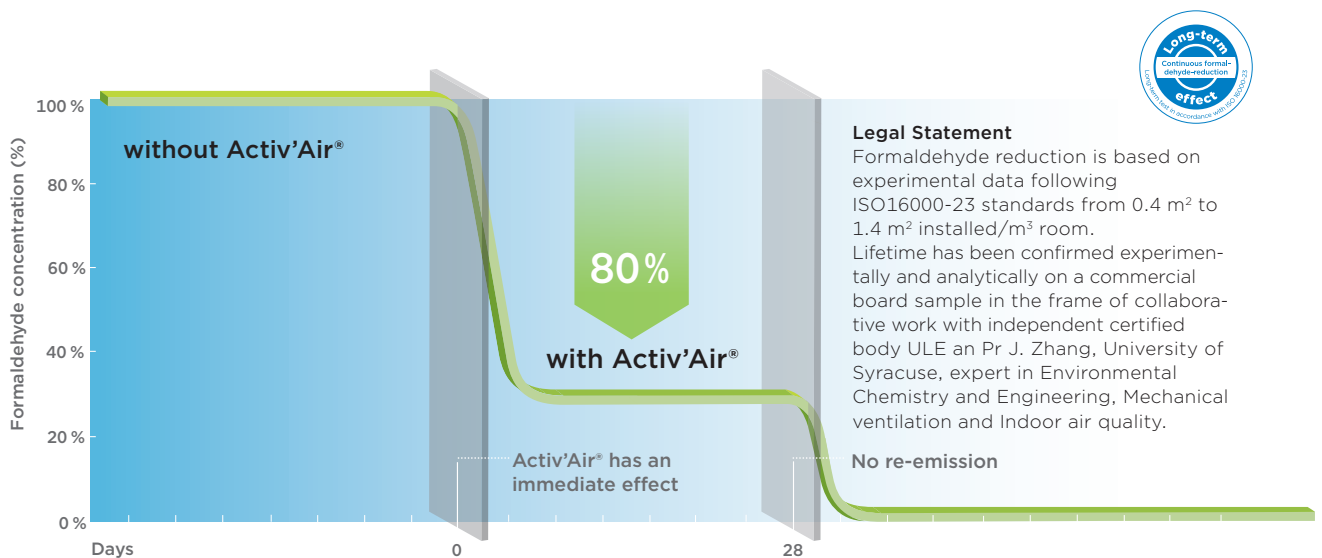
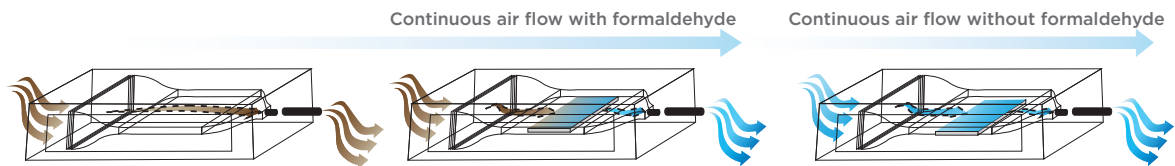

Activ'Air® air cleaning power

Activ'Air surface area needed to achieve the air cleaning power effect

Installing Rigitone Activ'Air and other Rigiaps Activ'Air products enables the permanent removal of up to 80% of formaldehyde from the room air. You can use the adjacent table to calculate how many square metres of Rigitone Activ'Air you should install in a room.

Absorption (CH ₂ O)	Ratio of surface / room volume (m ² /m ³)	Application areas
60%	0.4	Ceilings
70%	1.0	Walls
80%	1.2	Walls & ceilings

Extract: International formaldehyde concentration limits in room air

ppm	mg/m ³	
0.30	0.37	Health & Safety Institute
0.10	0.13	Maximum guideline value of the German Health Authority, German Federal Institute for Risk Assessment (BfR) and German Environment Agency
0.08	0.10	WHO (World Health Organisation) limit (maximum short-term concentration) Portuguese limit (maximum long-term concentration)
0.04	0.05	Polish limit (maximum long-term concentration)
0.02	0.03	French limit for public buildings (maximum average long-term concentration) from 2015
0.01	0.01	Belgian and French limit for public buildings (maximum average long-term concentration) from 2023
0	0	

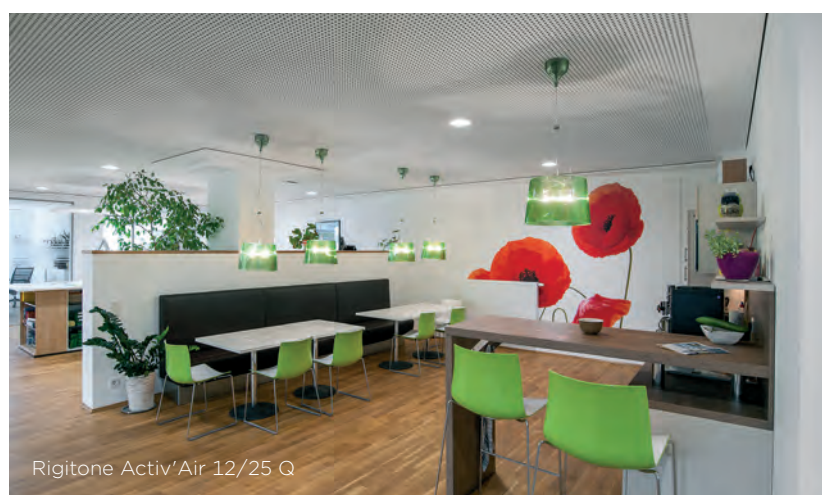

Practical test proves the Activ'Air® air cleaning power effect

The effect of Gyptone Activ'Air was impressively proven in a practical test at a school in Kallo, Belgium. The latest investigation results published by the independent Belgian Institute VITO demonstrate the special air cleaning power particularly clearly.

One classroom was fitted with a normal acoustic ceiling, the other with a Gyptone Activ'Air acoustic ceiling. Around 20 children were taught in both rooms. The classrooms had a volume of approx. 140 m³ and a normal ceiling height for such rooms of around 2.40 m, resulting in a highly typical ratio of ceiling surface to room volume of approx. 0.4.

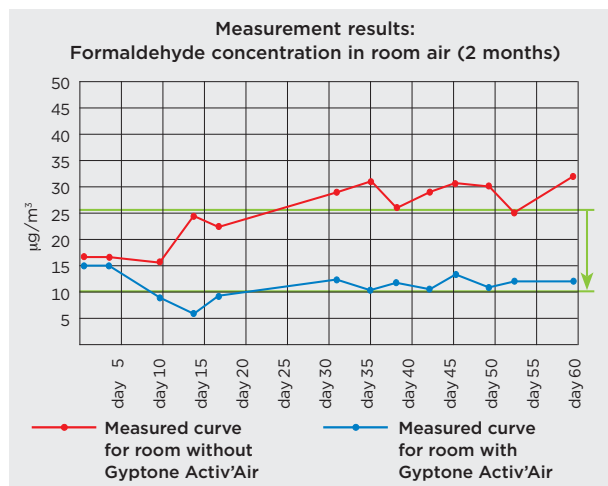

The sensors installed in the classrooms recorded the concentration of formaldehyde, a common pollutant which can be released e.g. from paints, furniture or floor coverings. In a direct comparison of the measurement results from the two test rooms, the independent testers found that the Gyptone Activ'Air acoustic ceiling had reduced the harmful gas by around 60% after the first two months. After five months the figure was 72%.

The patented Activ'Air air cleaning power remains effective for many years, meaning that the formaldehyde concentration will continue to fall. The air in sensitive and busy rooms e.g. in kindergartens or open-plan offices can therefore be quickly and permanently improved.



Room acoustic calculator

With its room acoustic calculator program, Rigips offers you an easy way to calculate reverberation times and plan room acoustic. Simply enter information about room geometry and fittings. The appropriate tolerance range for the reverberation times is then calculated from the room volume and intended use (grey curves). All results are automatically recalculated if you amend any of the entry fields.

Use this powerful tool at rigips.de/raumakustik-rechner (Please note that this program is in German).

Offer texts/CAD details

In particular in major construction projects, structures which can meet high structural and fire/sound protection requirements far in excess of those set out in drywall construction standards are preferred. Specially coordinated systems, with outstanding properties verified by certified testing institutes, are needed to meet these high requirements. Detailed offer texts are a key aid to clear description and safe installation. In many cases, a precise description of specific details is also only possible in the form of diagrams.

Offer texts and CAD details are provided online. The individual Rigips offer texts are available in seven different file formats (HTML, PDF, DOC, GAEB, ÖNORM, text, XML) and can be found on the corresponding results page of the Rigips system search. All offer texts have also been collated as downloads in three file formats (XML, Word, GAEB).

The CAD details from brochures and technical guidelines can also be easily accessed in five different CAD formats (PDF, 2 DWG variants, DXF, JPG) at rigips.de/downloads (Please note that this information is in German).

In addition to texts for tenders and CAD details, you can also find the latest relevant extracts from "Planen und Bauen" ("Planning and construction" - German only) and order the corresponding inspection certificate via the web form.

RiKS 3.0 – Rigips costing service

Plan and cost Rigips systems easily, quickly and precisely. RiKS 3.0 offers you the following advantages:

- Straightforward registration free of charge at rigips.de
- Plan and cost Rigips systems using the quick costing or within a project
- Use the Rigips system search to find the right systems quickly and easily by system number, keywords or properties.
- Option to select favourites
- Save up to 50 projects
- Output of complete bills of materials including article numbers/names, consumption volumes and list prices
- Output of installation times for the necessary working steps
- Individual customising options for all values with learning function
- Automatic calculation of wage costs on entry of an hourly wage
- Option to extend costings manually
- Output of a costing sheet with the results and system drawings
- Output of a material requirements list
- Output of a material order list
- Output of a scheduling list
- Simple offer preparation
- Printed lists can be generated as PDF files with your company data and logo

The screenshot displays the 'RiKS - Rigips Kalkulatorservice' web application. It features a navigation bar with options like 'Schnell-Kalkulation', 'Meine Projekte', and 'Einstellungen'. The main area is divided into a configuration section on the left and a detailed material list on the right. The configuration section includes fields for 'Grundeneinstellungen' (e.g., 'Zuschlag Lohn', 'Zuschlag Material') and 'System' (e.g., 'AD10RTA mit Rigips Rigitone Aktiv'). The material list table below shows various components like 'Rigips Rigitone Aktiv' and 'Rigips Rigitone Aktiv', with columns for 'Menge', 'Menge/Verbrauch', 'Wert', and 'Kosten'. A summary table at the bottom provides a total cost of 35.97 EUR.

Rigips project consulting

It is rare that the requirements of modern construction projects can be met with standard systems. The development of individual solutions tailored to the specific situation is a challenge which should not be underestimated, particularly with respect to fire/sound protection and acoustic room design. With the Rigips project consulting service, we have created a point of contact for planners and architects which offers technical and economic advantages and solutions based on project-specific research. The potential for savings is greatest and can be realised most effectively in the early planning phases, thus optimizing your design scope.

The screenshot shows the Rigips website homepage. It has a clean, modern design with a navigation bar at the top. The main content area features a large image of a modern interior space with a glass partition. Below this, there is a section titled 'RIGIPS für Architekten: Informationen und Inspirationen' which includes a 'Downloads' button and a list of resources such as 'Raumakustik - Lösungen von RIGIPS® - Form und Funktion in Vollendung' and 'Schallschutz Lösungen von RIGIPS - Umfassend planen und sicher realisieren'. There are also two smaller images with captions: 'Planen & Bauen online' and 'Ausarbeitungstexte'.

Room design for
eyes and ears





The comprehensive Rigitone range from Rigips comprises high-quality acoustic perforated boards made from gypsum, which is a natural raw material. This range enables the creation of jointless ceiling systems with harmonious and architecturally appealing ceiling patterns, and outstanding acoustic properties. Why not take a look at the wide range available.

Rigitone® Activ'Air®

boards are premium-quality perforated plasterboards with detailed designs which combine function and aesthetics: In addition to their wide range of perforation patterns, Rigitone Activ'Air boards also demonstrate optimum acoustic properties, particularly in the frequency range of the human voice. All Rigitone Activ'Air boards include Activ'Air premium air cleaning power as standard and ensure a sustainable reduction in air pollutants such as formaldehyde.

Rigitone® Climafit

are graphite-modified perforated plasterboards with outstanding thermal conductivity = $0.52 \text{ W}/(\text{m} \cdot \text{K})$. They are used as high-performance panelling for modern temperature control systems such as heating or cooling ceilings. The innovative combination of gypsum – an attractive material for interior use – and highly thermally conductive graphite ensure efficient temperature control and thus an ideal and natural indoor climate. Rigitone Climafit boards are available in a total of ten different perforation designs.

Product range:
Rigitone® Activ'Air® and
Rigitone® Climafit®

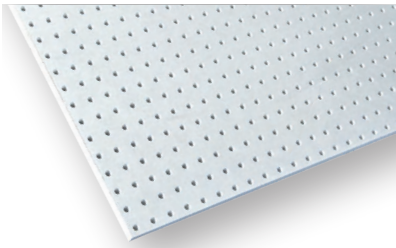

6/18 R

Rigitone® Activ'Air®,
Rigitone® Climafit®

Regular round perforation

Width x length: 1,188 x 1,998 mm

Perforated area: 8.7%

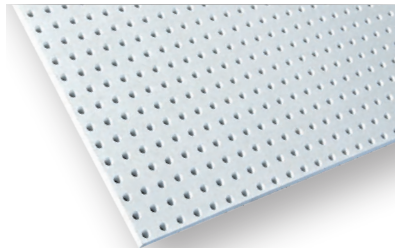

8/18 R

Rigitone® Activ'Air®,
Rigitone® Climafit®

Regular round perforation

Width x length: 1,188 x 1,998 mm

Perforated area: 15.5%

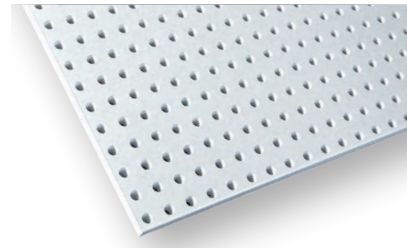

10/23 R

Rigitone® Activ'Air®

Regular round perforation

Width x length: 1,196 x 2,001 mm

Perforated area: 14.8%

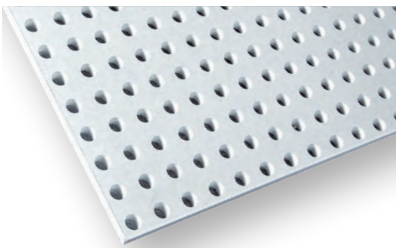

15/30 R

Rigitone® Activ'Air®

Regular round perforation

Width x length: 1,200 x 1,980 mm

Perforated area: 19.6%

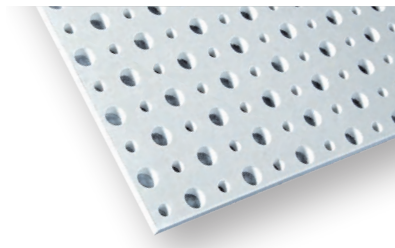

12-20/66 R

Rigitone® Activ'Air®

Regularly staggered round perforation

Width x length: 1,188 x 1,980 mm

Perforated area: 19.6%

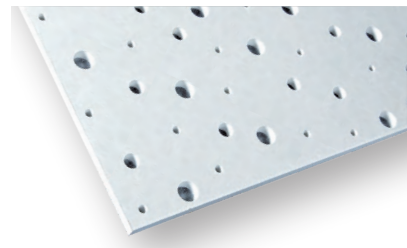

12-15-20 R

Rigitone® Activ'Air®

Irregular scattered perforation

Width x length: 1,200 x 2,000 mm

Perforated area: 6.0%

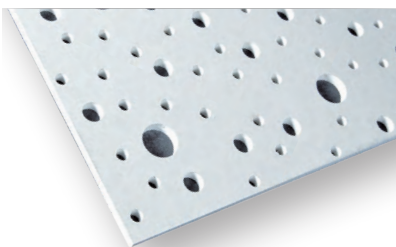

12-20-35 R

Rigitone® Activ'Air®

Irregular scattered perforation

Width x length: 1,200 x 2,000 mm

Perforated area: 11.0%

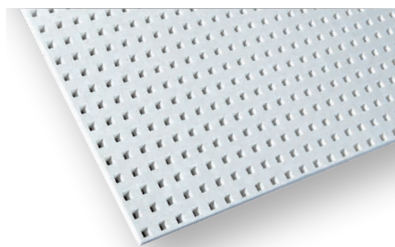

8/18 Q

Rigitone® Activ'Air®,
Rigitone® Climafit®

Regular square perforation

Width x length: 1,188 x 1,998 mm

Perforated area: 19.8%

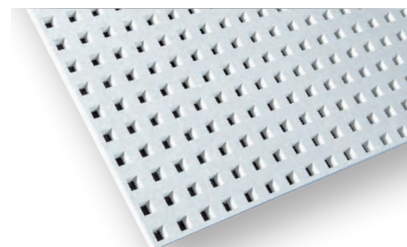

12/25 Q

Rigitone® Activ'Air®,
Rigitone® Climafit®

Regular square perforation

Width x length: 1,200 x 2,000 mm

Perforated area: 23.0%

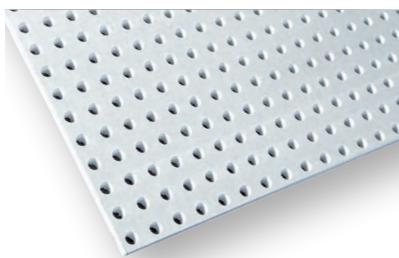

12/25 R

Rigitone® Activ'Air®

Regular round perforation

Width x length: 1,200 x 2,000 mm

Perforated area: 18.1%

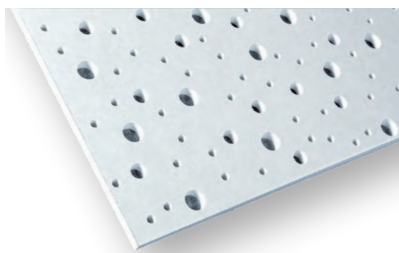

8-15-20 super R

**Rigitone® Activ'Air®,
Rigitone® Climafit®**

Irregular scattered perforation

Width x length: 1,200 x 1,960 mm

Perforated area: 10.0%

Product properties

The Rigitone board range comprises perforation designs with regular and regularly staggered round perforations, irregular scattered perforations and square perforations. They are fitted with white or black acoustic tissue as standard and demonstrate very good sound-absorbing properties, particularly in the frequency range of the human voice.

Surface finish

The surfaces of Rigitone boards are untreated. After installation and joint filling, the boards should be primed and then painted with a paint roller. Paint should not be applied using a spray diffuser.

Reaction to fire

Rigitone boards are designated as A2-s1, d0 (C.4) - non-combustible - in accordance with DIN EN 13501-1.

Installation instructions

The Joint Filling Technique with Rigips VARIO or Rigitone Mix should be employed for the jointless installation of Rigitone perforated boards with continuous perforation. Rigitone boards are ready to install because of its pre-sanded and primed edges at factory site. Cut edges have to be pre-sanded and primed. Rikombi Grund should be used as priming coat. The recommended mixing ratio is 1 : 2.

Structural prerequisites

Rigitone boards can be used in all rooms where the relative humidity does not exceed 70%. There should be a constant board and room temperature of at least 5 °C during joint filling.

Renovation

The board surface can easily be re-painted during any renovation work without impacting the properties of the boards. However, paint should not be applied using a spray diffuser.

Board dimensions







Filled joint



Nominal size - 3.6 mm = actual size





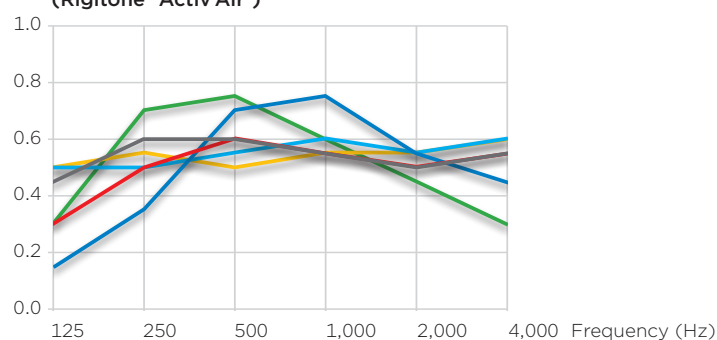

For the irregular scattered perforation pattern 8-15-20 R, 8-15-20 super R and 12-20-35 R, the nominal size is the same as the actual size.

Rigitone® Activ'Air® and Rigitone® Climafit® 6 / 18 R

	Rigitone® Activ'Air®	Rigitone® Climafit®
 System number	AD10RTA	
 Board thickness in mm	12.5	10
 Weight in kg/m ²	ca. 9.5	ca. 7.9
 Perforated area in %	8.7	8.7
 Centre-to-centre distance between support profiles in mm	333	333
 Air cleaning power Activ'Air	✓	-
 Reaction to fire in accordance with DIN EN 14190	A2-s1, d0	A2-s1, d0

Practical sound absorption coefficient α_p
(Rigitone® Activ'Air®)



	α_w	NRC	Class
 Suspension height 30 mm, mineral wool layer 30 mm ¹⁾	0.30 0.50 0.60 0.55 0.50 0.55	0.55	D
 Suspension height 50 mm	0.15 0.35 0.70 0.75 0.55 0.45	0.55	D
 Suspension height 50 mm, mineral wool layer 50 mm (30+20) ¹⁾	0.45 0.60 0.60 0.55 0.50 0.55	0.55	D
 Suspension height 200 mm	0.30 0.70 0.75 0.60 0.45 0.30	0.45 (LM)	D
 Suspension height 200 mm, mineral wool layer 50 mm (30+20) ¹⁾	0.50 0.55 0.50 0.55 0.55 0.60	0.55	D
 Suspension height 400 mm, mineral wool layer 50 mm (30+20) ¹⁾	0.50 0.50 0.55 0.60 0.55 0.60	0.60	C

¹⁾ e.g. ISOVER Akustic SSP 1 or Ultimate TP-039

6/18 R

**Rigitone® Activ'Air®,
Rigitone® Climafit®**

Regular round perforation

Width x length: 1,188 x 1,998 mm

Perforated area: 8.7%

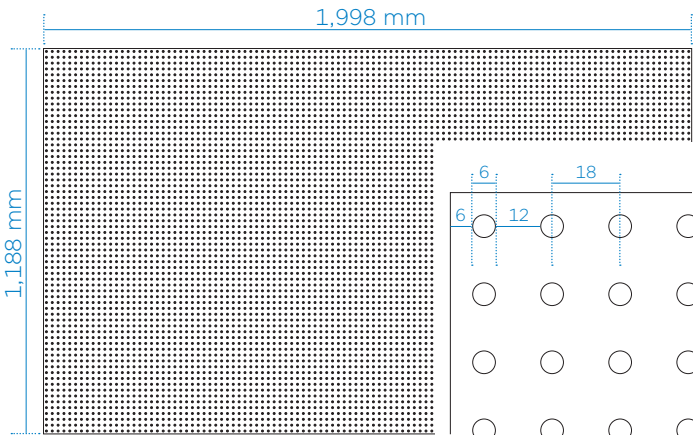
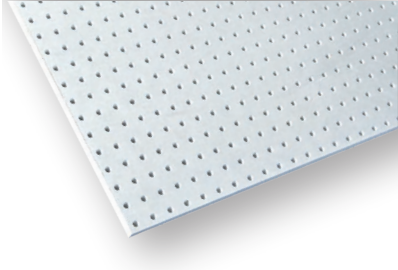
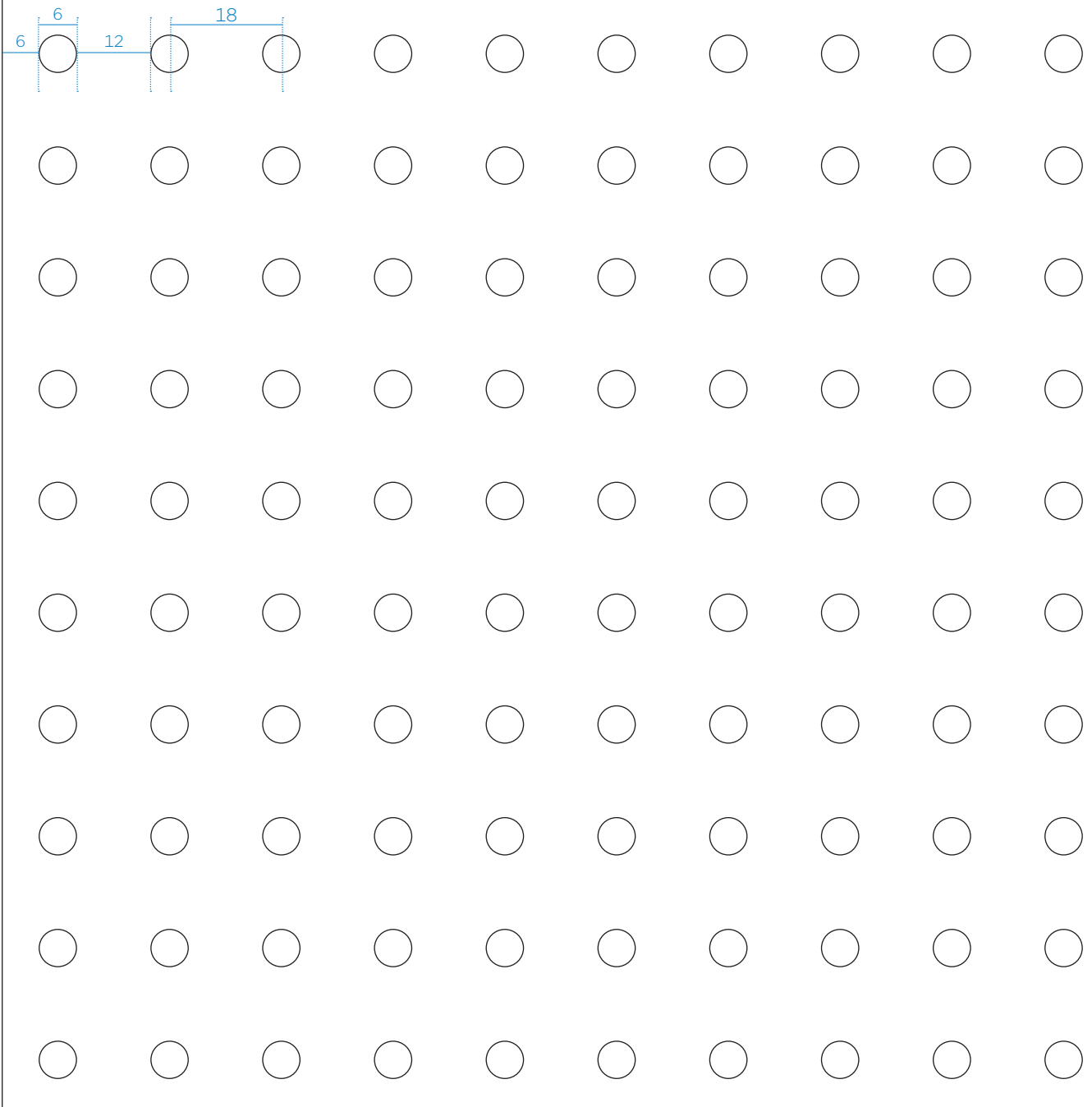









Diagram scale 1:1



Rigitone® Activ'Air® and Rigitone® Climafit®

8/18 R

	Rigitone® Activ'Air®	Rigitone® Climafit®
 System number	AD10RTA	
 Board thickness in mm	12.5	10
 Weight in kg/m ²	ca. 8.8	ca. 7.3
 Perforated area in %	15.5	15.5
 Centre-to-centre distance between support profiles in mm	333	333
 Air cleaning power Activ'Air	✓	-
 Reaction to fire in accordance with DIN EN 14190	A2-s1, d0	A2-s1, d0

Practical sound absorption coefficient α_p (Rigitone® Activ'Air®)

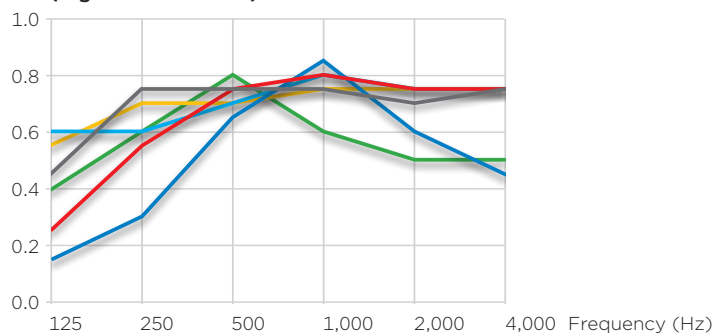

	α_w	NRC	Class
Suspension height 30 mm, mineral wool layer 30 mm¹⁾	0.25 0.55 0.75 0.80 0.75 0.75	0.75	0.70 C
Suspension height 50 mm	0.15 0.30 0.65 0.85 0.60 0.45	0.55 (M)	0.60 D
Suspension height 50 mm, mineral wool layer 50 mm (30+20)¹⁾	0.45 0.75 0.75 0.75 0.70 0.75	0.75	0.75 C
Suspension height 200 mm	0.40 0.60 0.80 0.60 0.50 0.50	0.60	0.65 C
Suspension height 200 mm, mineral wool layer 50 mm (30+20)¹⁾	0.55 0.70 0.70 0.75 0.75 0.75	0.75	0.70 C
Suspension height 400 mm, mineral wool layer 50 mm (30+20)¹⁾	0.60 0.60 0.70 0.80 0.75 0.75	0.75	0.70 C

¹⁾e.g. ISOVER Akustic SSP 1 or Ultimate TP-039

8 / 18 R

Rigitone® Activ'Air®,
Rigitone® Climafit®

Regular round perforation

Width x length: 1,188 x 1,998 mm

Perforated area: 15.5%

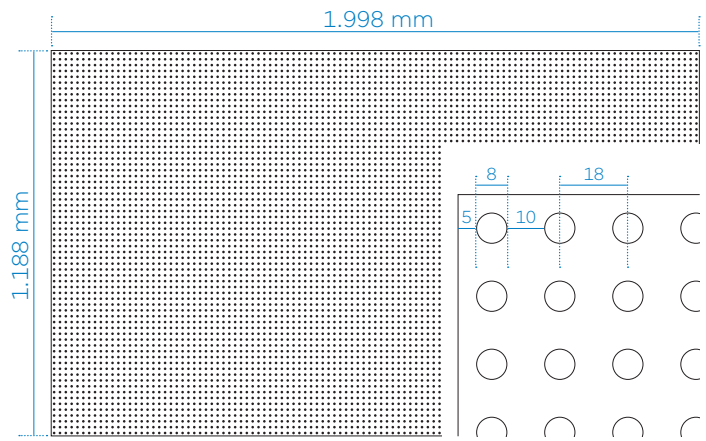
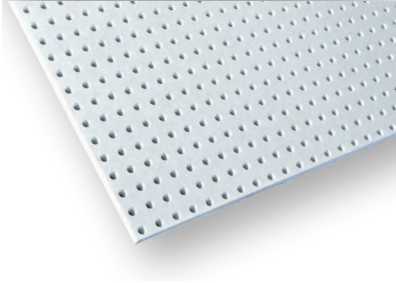
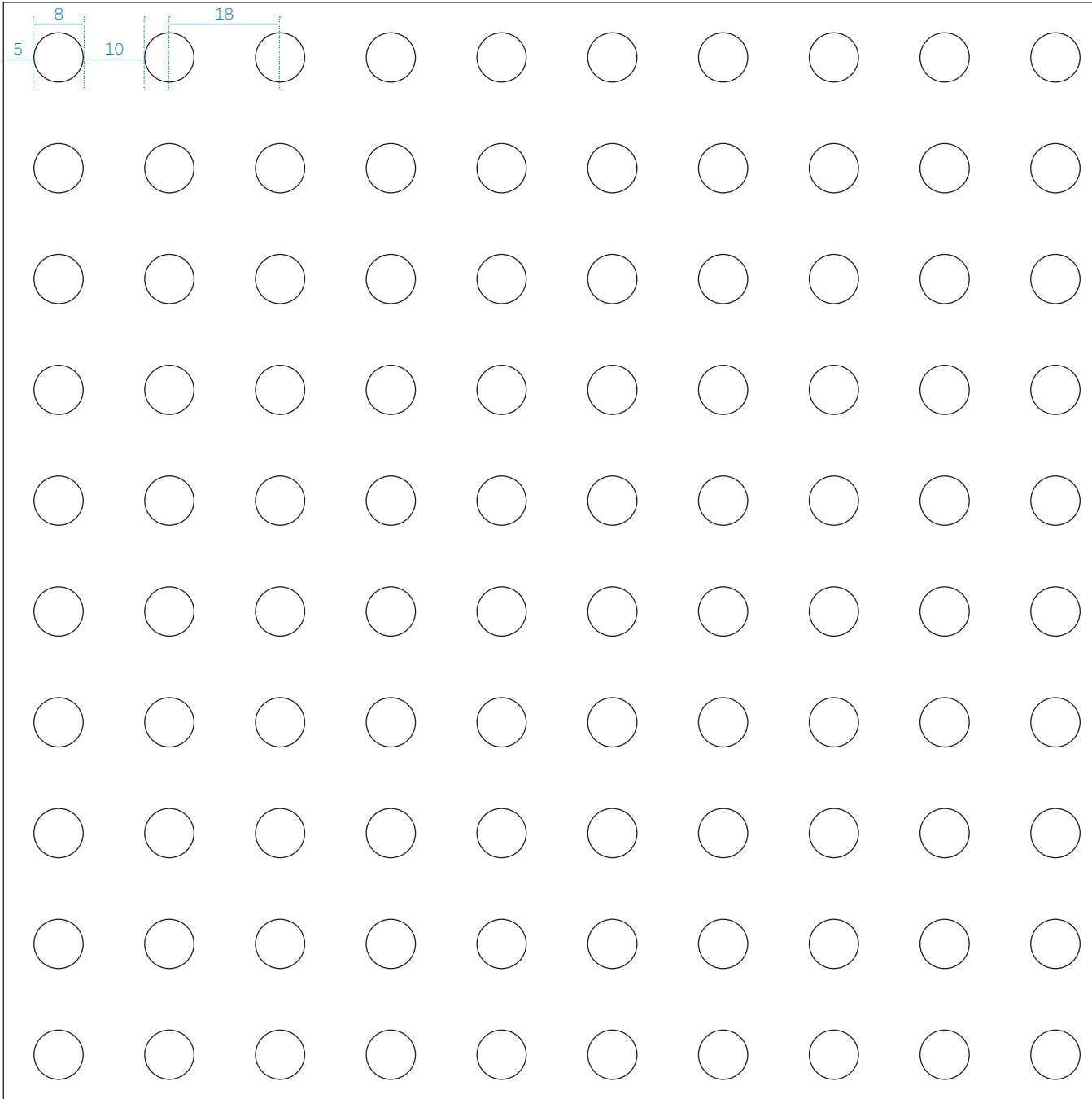









Diagram scale 1:1







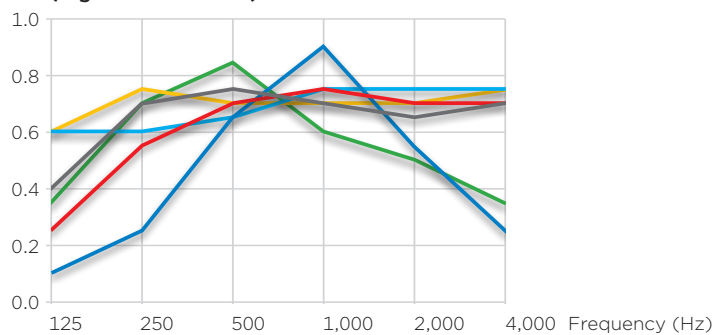

Rigitone® Activ'Air® 10/23 R

Rigitone® Activ'Air®	
 System number	AD10RTA
 Board thickness in mm	12.5
 Weight in kg/m ²	ca. 8.8
 Perforated area in %	14.8
 Centre-to-centre distance between support profiles in mm	333
 Air cleaning power Activ'Air	✓
 Reaction to fire in accordance with DIN EN 14190	A2-s1, d0

Practical sound absorption coefficient α_p
(Rigitone® Activ'Air®)



	α_w	NRC	Class
 Suspension height 30 mm, mineral wool layer 30 mm ¹⁾	0.25 0.55 0.70 0.75 0.70 0.70	0.75 0.70	C
 Suspension height 50 mm	0.10 0.25 0.65 0.90 0.55 0.25	0.45 (M) 0.60	D
 Suspension height 50 mm, mineral wool layer 50 mm (30+20) ¹⁾	0.40 0.70 0.75 0.70 0.65 0.70	0.70 0.70	C
 Suspension height 200 mm	0.35 0.70 0.85 0.60 0.50 0.35	0.50 (LM) 0.65	D
 Suspension height 200 mm, mineral wool layer 50 mm (30+20) ¹⁾	0.60 0.75 0.70 0.70 0.70 0.75	0.70 (L) 0.70	C
 Suspension height 400 mm, mineral wool layer 50 mm (30+20) ¹⁾	0.60 0.60 0.65 0.75 0.75 0.75	0.75 0.70	C

¹⁾e.g. ISOVER Akustic SSP 1 or Ultimate TP-039

10/23 R

Rigitone® Activ'Air®

Regular round perforation

Width x length: 1,196 x 2,001 mm

Perforated area: 14.8%

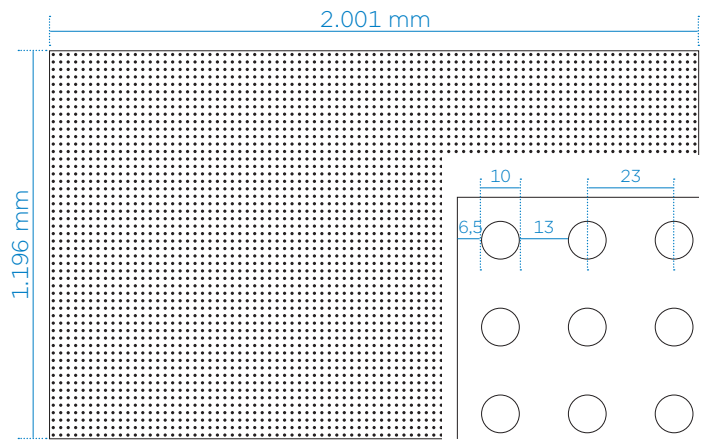
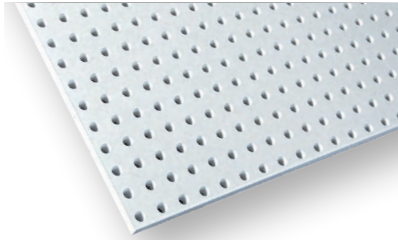
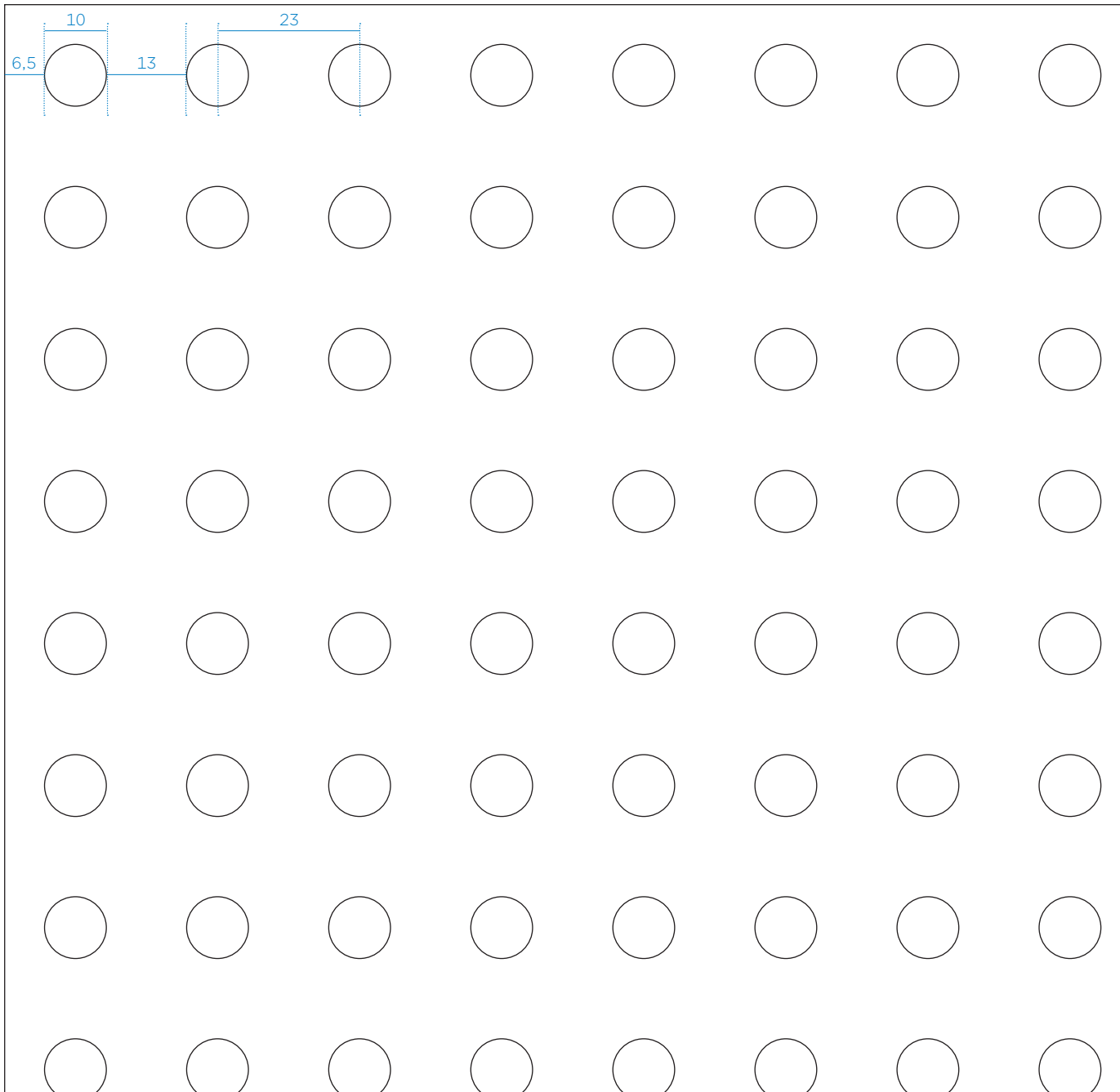

Diagram scale 1:1











Office building OKEL, Diemelstadt
Rigitone Activ'Air 8/18 Q



Rigitone® Activ'Air® 12/25 R

		Rigitone® Activ'Air®
	System number	AD10RTA
	Board thickness in mm	12.5
	Weight in kg/m ²	ca. 8.5
	Perforated area in %	18.1
	Centre-to-centre distance between support profiles in mm	333
	Air cleaning power Activ'Air	✓
	Reaction to fire in accordance with DIN EN 14190	A2-s1, d0

Practical sound absorption coefficient α_p
(Rigitone® Activ'Air®)

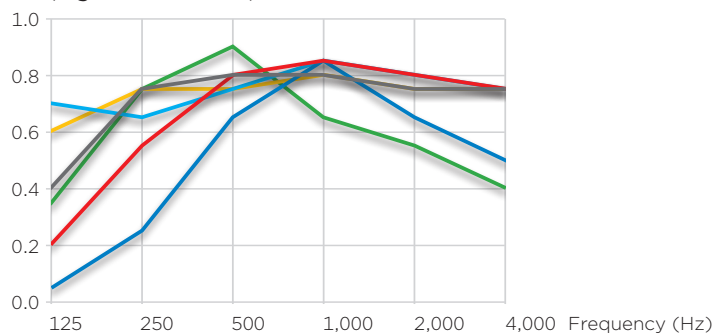

	α_w						NRC	Class	
— Suspension height 30 mm, mineral wool layer 30 mm ¹⁾	0.20	0.55	0.80	0.85	0.80	0.75	0.80	0.75	B
— Suspension height 50 mm	0.05	0.25	0.65	0.85	0.65	0.50	0.55 (M)	0.60	D
— Suspension height 50 mm, mineral wool layer 50 mm (30+20) ¹⁾	0.40	0.75	0.80	0.80	0.75	0.75	0.80	0.80	B
— Suspension height 200 mm	0.35	0.75	0.90	0.65	0.55	0.40	0.55 (LM)	0.70	D
— Suspension height 200 mm, mineral wool layer 50 mm (30+20) ¹⁾	0.60	0.75	0.75	0.80	0.75	0.75	0.80	0.75	B
— Suspension height 400 mm, mineral wool layer 50 mm (30+20) ¹⁾	0.70	0.65	0.75	0.85	0.80	0.75	0.80	0.75	B

¹⁾e.g. ISOVER Akustic SSP 1 or Ultimate TP-039

12/25 R

Rigitone® Activ'Air®

Regular round perforation

Width x length: 1,200 x 2,000 mm

Perforated area: 18.1%

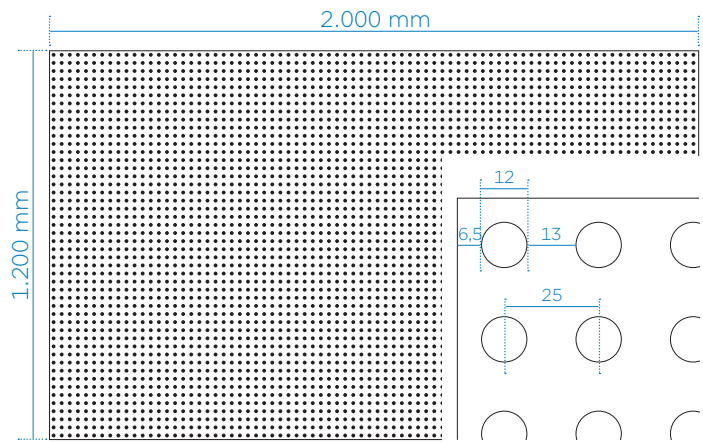
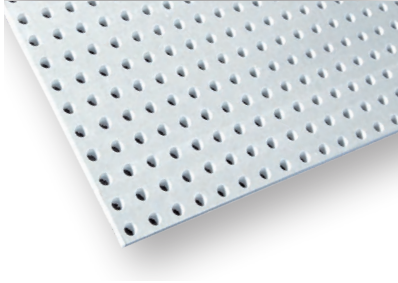









Diagram scale 1:1



Rigitone® Activ'Air® 15/30 R

		Rigitone® Activ'Air®
	System number	AD10RTA
	Board thickness in mm	12.5
	Weight in kg/m ²	ca. 8.4
	Perforated area in %	19.6
	Centre-to-centre distance between support profiles in mm	330
	Air cleaning power Activ'Air	✓
	Reaction to fire in accordance with DIN EN 14190	A2-s1, d0

Practical sound absorption coefficient α_p
(Rigitone® Activ'Air®)

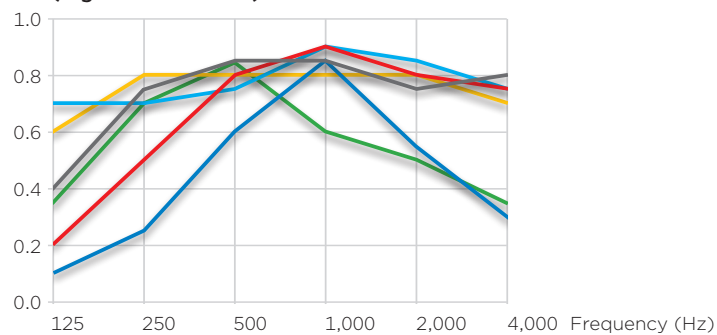

	125	250	500	1,000	2,000	4,000	α_w	NRC	Class
Suspension height 30 mm, mineral wool layer 30 mm¹⁾	0.20	0.50	0.80	0.90	0.80	0.75	0.80	0.75	B
Suspension height 50 mm	0.10	0.25	0.60	0.85	0.55	0.30	0.45 (M)	0.55	D
Suspension height 50 mm, mineral wool layer 50 mm (30+20)¹⁾	0.40	0.75	0.85	0.85	0.75	0.80	0.85	0.80	B
Suspension height 200 mm	0.35	0.70	0.85	0.60	0.50	0.35	0.50 (LM)	0.65	D
Suspension height 200 mm, mineral wool layer 50 mm (30+20)¹⁾	0.60	0.80	0.80	0.80	0.80	0.70	0.80	0.80	B
Suspension height 400 mm, mineral wool layer 50 mm (30+20)¹⁾	0.70	0.70	0.75	0.90	0.85	0.75	0.85	0.80	B

¹⁾e.g. ISOVER Akustic SSP 1 or Ultimate TP-039

15/30 R

Rigitone® Activ'Air®

Regular round perforation

Width x length: 1,200 x 1,980 mm

Perforated area: 19.6%

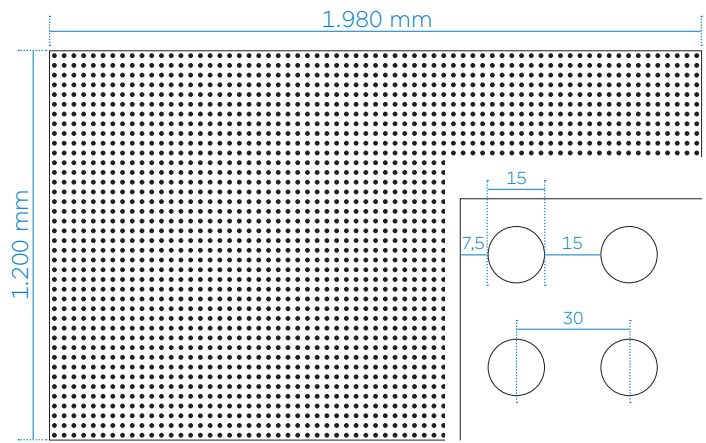
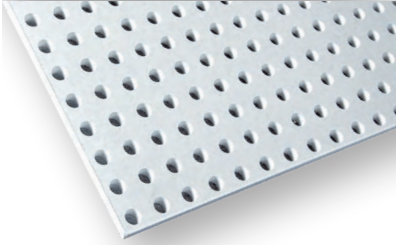
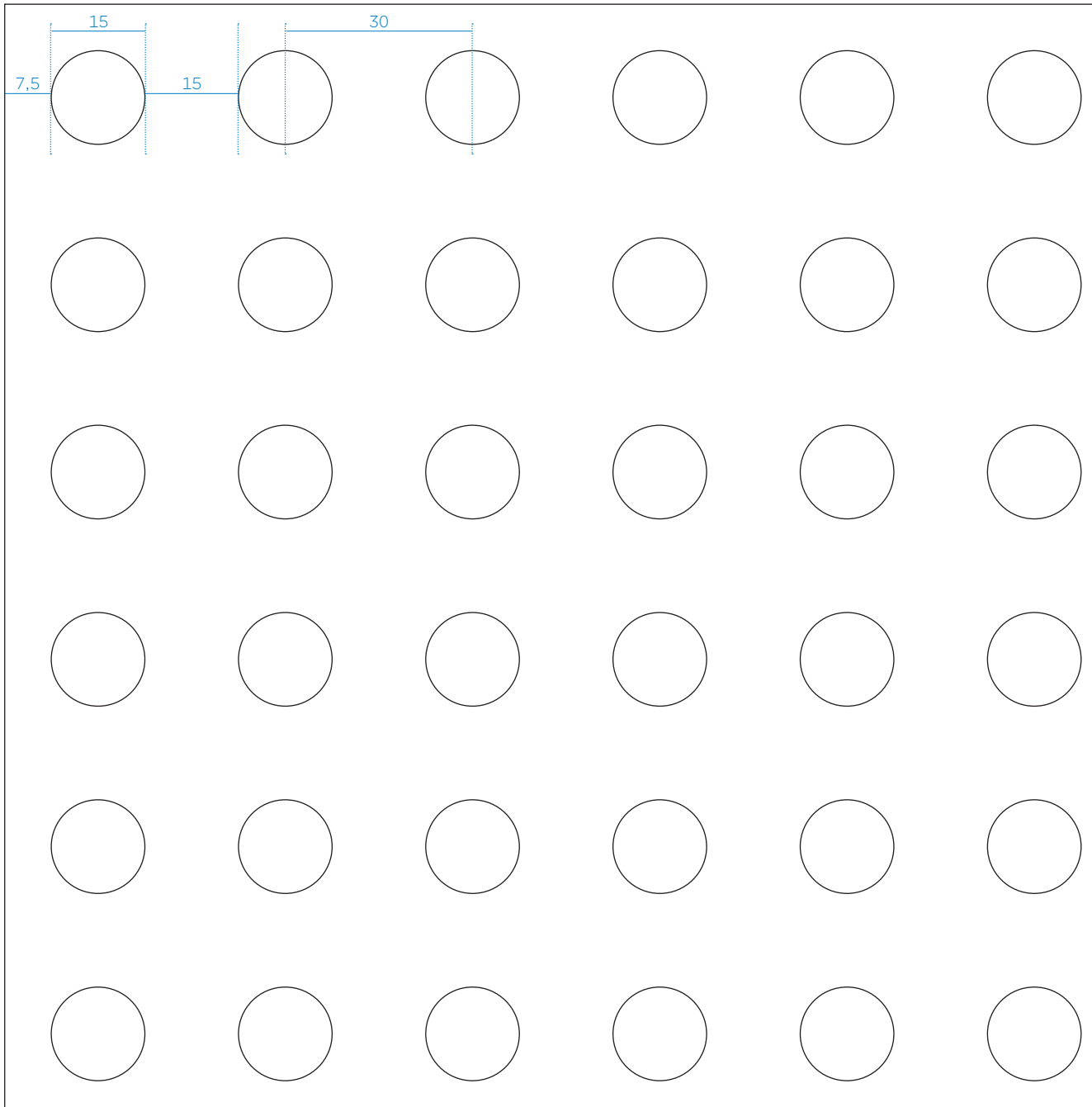









Diagram scale 1:1



Rigitone® Activ'Air® 12-20/66 R

		Rigitone® Activ'Air®
	System number	AD10RTA
	Board thickness in mm	12.5
	Weight in kg/m ²	ca. 8.4
	Perforated area in %	19.6
	Centre-to-centre distance between support profiles in mm	330
	Air cleaning power Activ'Air	✓
	Reaction to fire in accordance with DIN EN 14190	A2-s1, d0

Practical sound absorption coefficient α_p
(Rigitone® Activ'Air®)

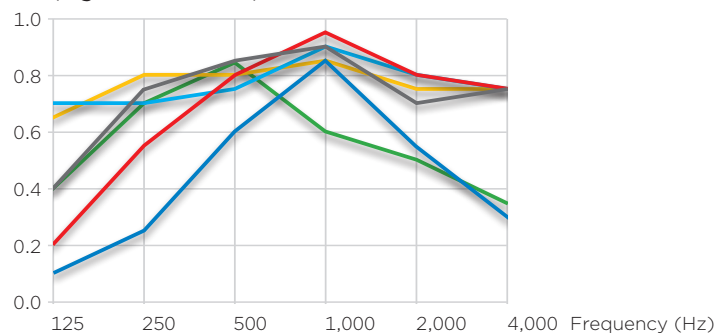

	α_w						NRC	Class	
— Suspension height 30 mm, mineral wool layer 30 mm ¹⁾	0.20	0.55	0.80	0.95	0.80	0.75	0.80	0.75	B
— Suspension height 50 mm	0.10	0.25	0.60	0.85	0.55	0.30	0.45 (M)	0.55	D
— Suspension height 50 mm, mineral wool layer 50 mm (30+20) ¹⁾	0.40	0.75	0.85	0.90	0.70	0.75	0.80	0.80	B
— Suspension height 200 mm	0.40	0.70	0.85	0.60	0.50	0.35	0.50 (LM)	0.65	D
— Suspension height 200 mm, mineral wool layer 50 mm (30+20) ¹⁾	0.65	0.80	0.80	0.85	0.75	0.75	0.80	0.80	B
— Suspension height 400 mm, mineral wool layer 50 mm (30+20) ¹⁾	0.70	0.70	0.75	0.90	0.80	0.75	0.80	0.80	B

¹⁾ e.g. ISOVER Akustic SSP 1 or Ultimate TP-039

12-20/66 R

Rigitone® Activ'Air®

Regularly staggered round perforation

Width x length: 1,188 x 1,980 mm

Perforated area: 19.6%

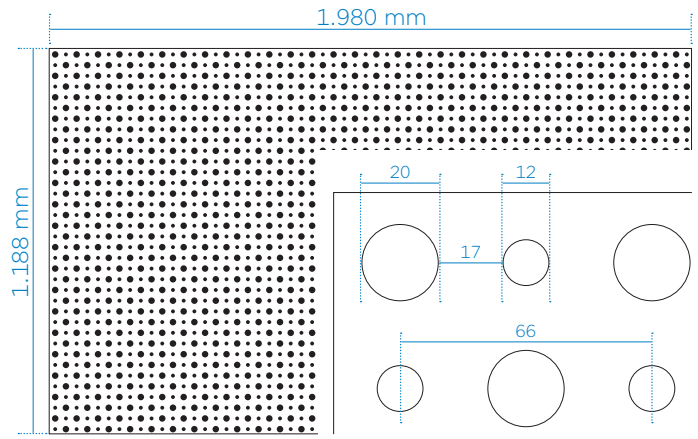
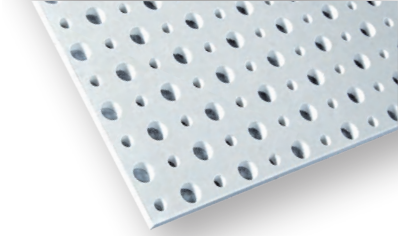
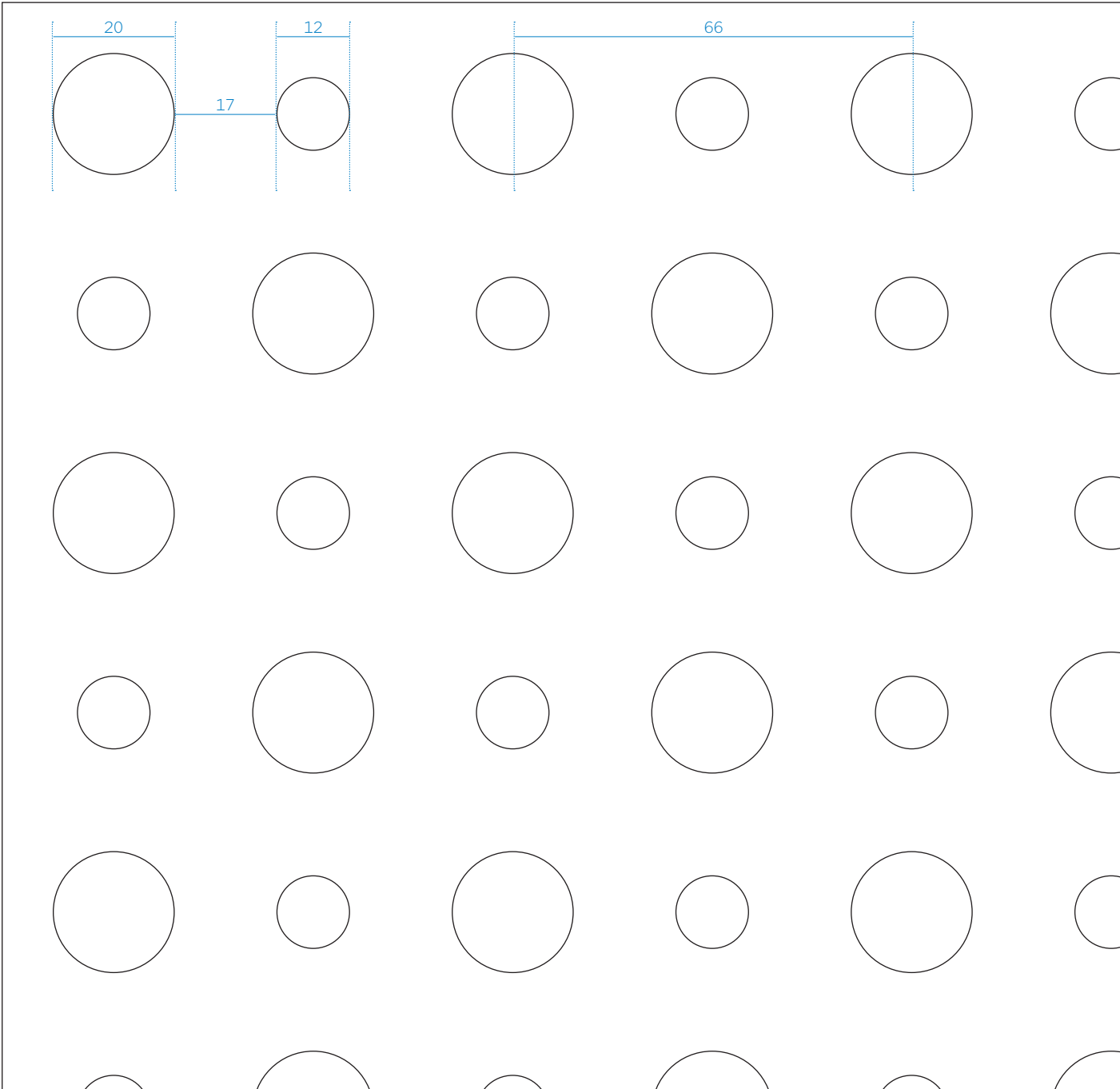









Diagram scale 1:1







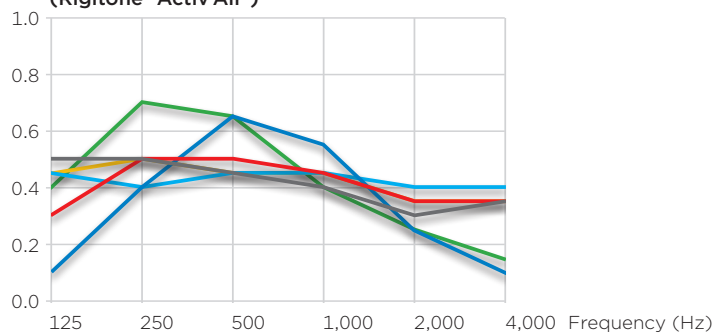

Rigitone® Activ'Air® 8-15-20 R

		Rigitone® Activ'Air®
	System number	AD10RTA
	Board thickness in mm	12.5
	Weight in kg/m ²	ca. 9.8
	Perforated area in %	6
	Centre-to-centre distance between support profiles in mm	333
	Air cleaning power Activ'Air	✓
	Reaction to fire in accordance with DIN EN 14190	A2-s1, d0

Practical sound absorption coefficient α_p
(Rigitone® Activ'Air®)



	α_w						NRC	Class	
 Suspension height 30 mm, mineral wool layer 30 mm ¹⁾	0.30	0.50	0.50	0.45	0.35	0.35	0.45	0.45	D
 Suspension height 50 mm	0.10	0.40	0.65	0.55	0.25	0.10	0.25 (LM)	0.45	E
 Suspension height 50 mm, mineral wool layer 50 mm (30+20) ¹⁾	0.50	0.50	0.45	0.40	0.30	0.35	0.40 (L)	0.40	D
 Suspension height 200 mm	0.40	0.70	0.65	0.40	0.25	0.15	0.30 (LM)	0.50	D
 Suspension height 200 mm, mineral wool layer 50 mm (30+20) ¹⁾	0.45	0.50	0.45	0.45	0.35	0.35	0.45	0.45	D
 Suspension height 400 mm, mineral wool layer 50 mm (30+20) ¹⁾	0.45	0.40	0.45	0.45	0.40	0.40	0.45	0.45	D

¹⁾ e.g. ISOVER Akustic SSP 1 or Ultimate TP-039

12-15-20 R

Rigitone® Activ'Air®

Irregular scattered perforation

Width x length: 1,200 x 2,000 mm

Perforated area: 6.0%

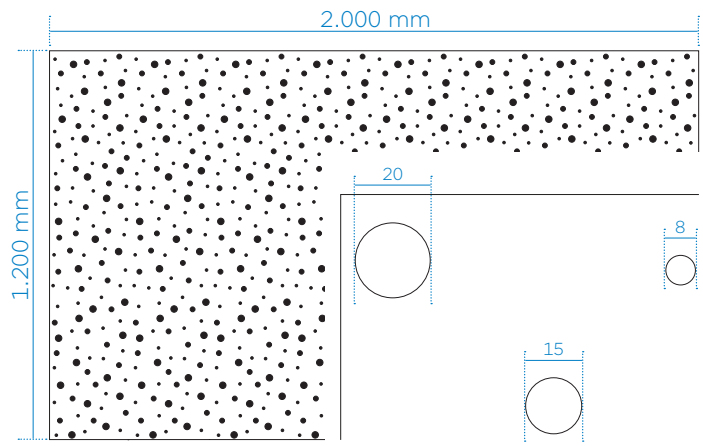
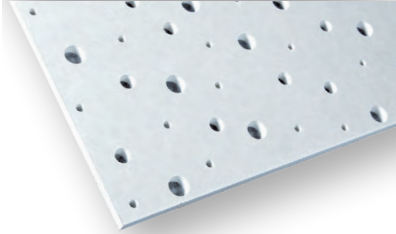
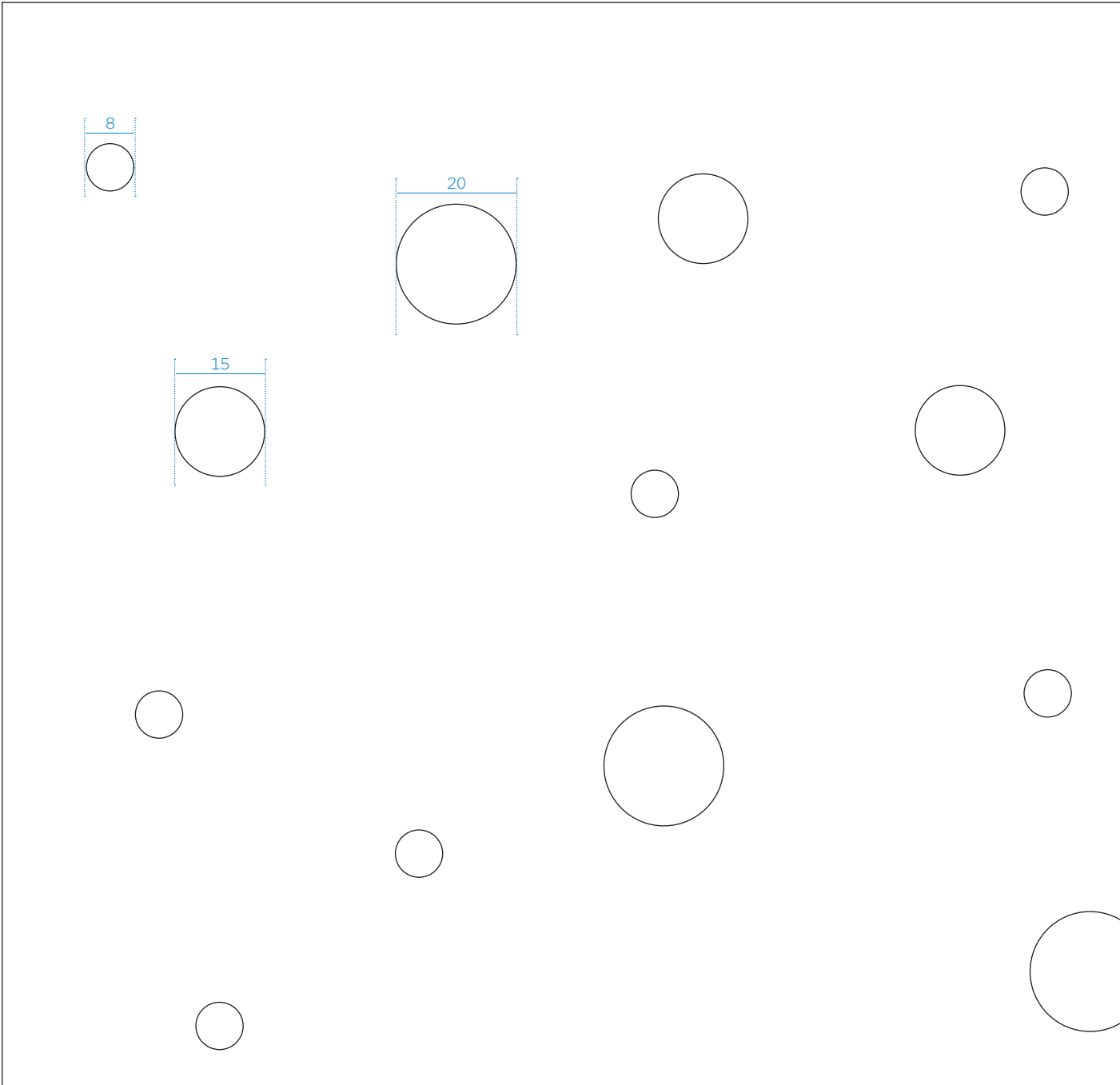









Diagram scale 1:1



Rigitone® Activ'Air® and Rigitone® Climafit® 8-15-20 super R

	Rigitone® Activ'Air®	Rigitone® Climafit®
 System number	AD10RTA	
 Board thickness in mm	12.5	10
 Weight in kg/m ²	ca. 9.3	ca. 7.8
 Perforated area in %	10	10
 Centre-to-centre distance between support profiles in mm	327	327
 Air cleaning power Activ'Air	✓	-
 Reaction to fire in accordance with DIN EN 14190	A2-s1, d0	A2-s1, d0

Practical sound absorption coefficient α_p
(Rigitone® Activ'Air®)

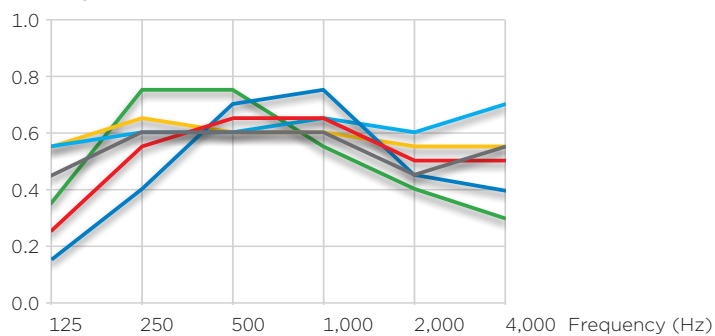

	α_w	NRC	Class	
Suspension height 30 mm, mineral wool layer 30 mm¹⁾	0.25 0.55 0.65 0.65 0.50 0.50	0.60	0.60	C
Suspension height 50 mm	0.15 0.40 0.70 0.75 0.45 0.40	0.50 (M)	0.60	D
Suspension height 50 mm, mineral wool layer 50 mm (30+20)¹⁾	0.45 0.60 0.60 0.60 0.45 0.55	0.55	0.55	D
Suspension height 200 mm	0.35 0.75 0.75 0.55 0.40 0.30	0.45 (LM)	0.60	D
Suspension height 200 mm, mineral wool layer 50 mm (30+20)¹⁾	0.55 0.65 0.60 0.60 0.55 0.55	0.60	0.60	C
Suspension height 400 mm, mineral wool layer 50 mm (30+20)¹⁾	0.55 0.60 0.60 0.65 0.60 0.70	0.65	0.60	C

¹⁾e.g. ISOVER Akustic SSP 1 or Ultimate TP-039

8-15-20 super R

Rigitone® Activ'Air®,
Rigitone® Climafit®

Irregular scattered perforation

Width x length: 1,200 x 1,960 mm

Perforated area: 10.0%

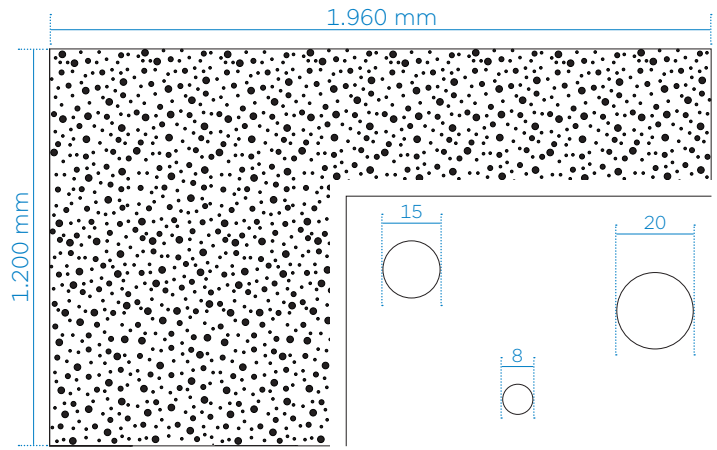
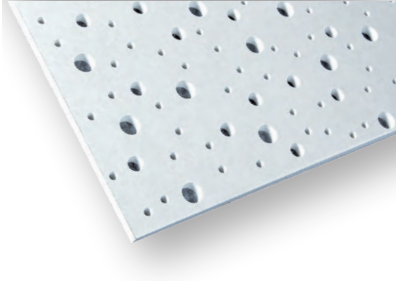
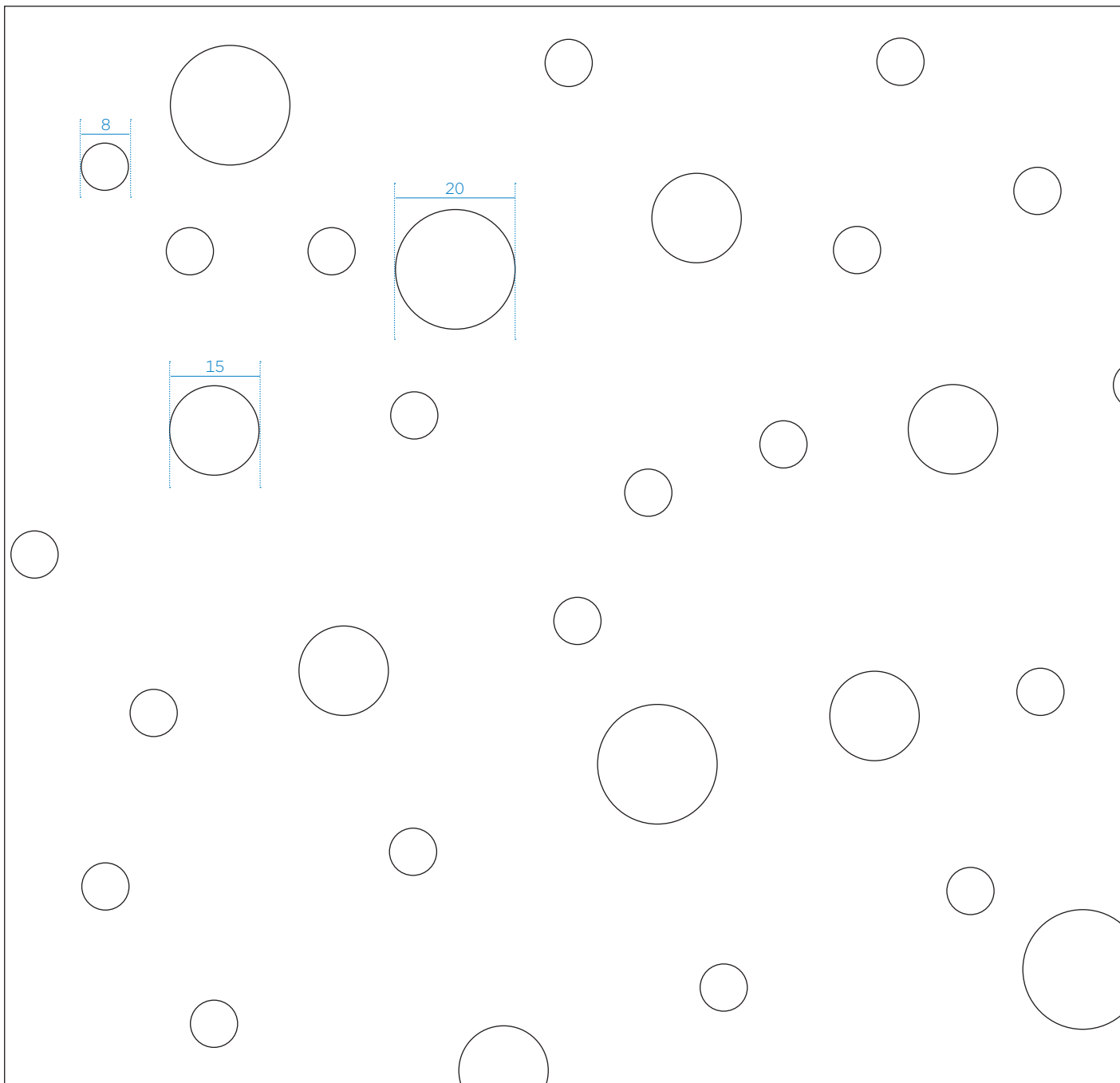









Diagram scale 1:1



Rigitone® Activ'Air® 12-20-35 R

		Rigitone® Activ'Air®
	System number	AD10RTA
	Board thickness in mm	12.5
	Weight in kg/m ²	ca. 9.2
	Perforated area in %	11
	Centre-to-centre distance between support profiles in mm	333
	Air cleaning power Activ'Air	✓
	Reaction to fire in accordance with DIN EN 14190	A2-s1, d0

**Practical sound absorption coefficient α_p
(Rigitone® Activ'Air®)**

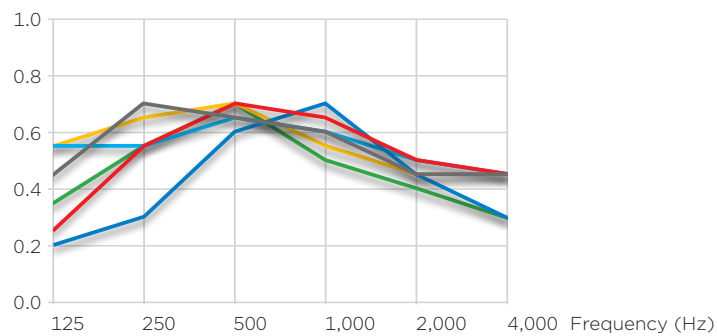

	α_w	NRC	Class
Suspension height 30 mm, mineral wool layer 30 mm¹⁾			
0.25	0.55	0.70	0.65
0.50	0.50	0.45	0.45
0.75	0.55	0.60	D
Suspension height 50 mm			
0.20	0.30	0.60	0.70
0.40	0.45	0.30	0.45
0.60	0.45	0.50	D
Suspension height 50 mm, mineral wool layer 50 mm (30+20)¹⁾			
0.45	0.70	0.65	0.60
0.90	0.45	0.45	0.45
1.35	0.55 (L)	0.60	D
Suspension height 200 mm			
0.35	0.55	0.70	0.50
0.70	0.40	0.30	0.45 (L)
1.05	0.50	0.50	D
Suspension height 200 mm, mineral wool layer 50 mm (30+20)¹⁾			
0.55	0.65	0.70	0.55
1.10	0.45	0.45	0.55 (L)
1.65	0.60	0.60	D
Suspension height 400 mm, mineral wool layer 50 mm (30+20)¹⁾			
0.55	0.55	0.65	0.60
1.10	0.50	0.45	0.55
1.65	0.60	0.60	D

¹⁾e.g. ISOVER Akustic SSP 1 or Ultimate TP-039

12-20-35 R

Rigitone® Activ'Air®

Irregular scattered perforation

Width x length: 1,200 x 2,000 mm

Perforated area: 11.0%

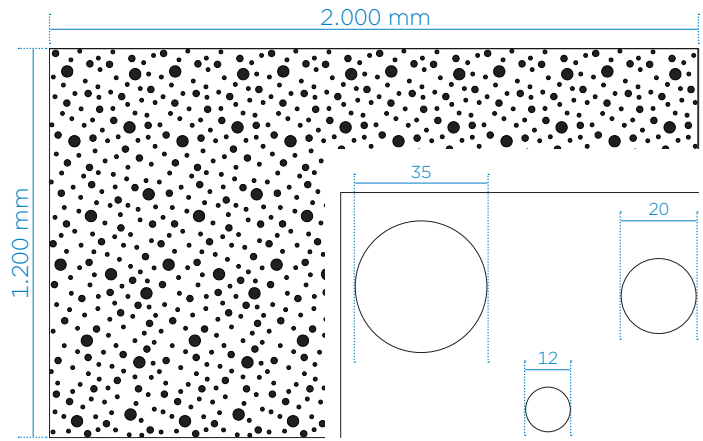
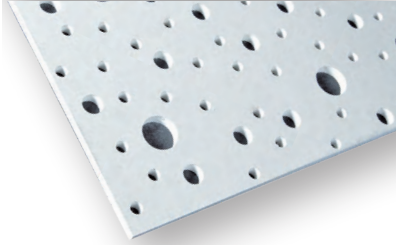
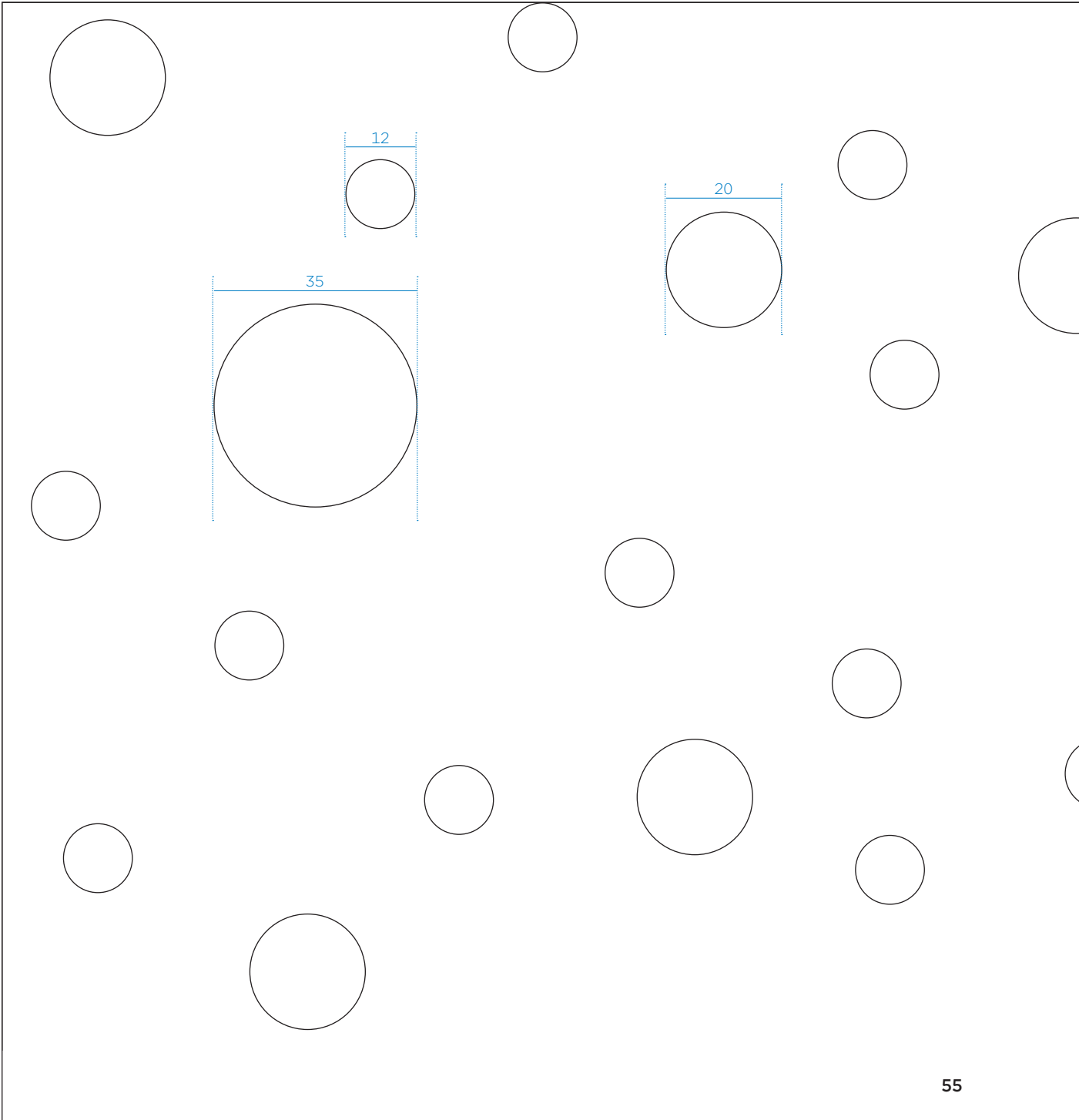

Diagram scale 1:1











Rigitone Activ'Air 12/25 Q







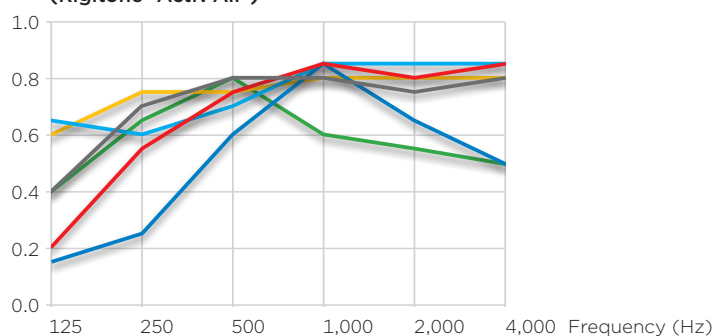

Rigitone® Activ'Air® and Rigitone® Climafit® 8/18 Q

	Rigitone® Activ'Air®	Rigitone® Climafit®
 System number	AD10RTA	
 Board thickness in mm	12.5	10
 Weight in kg/m ²	ca. 8.3	ca. 6.9
 Perforated area in %	19.8	19.8
 Centre-to-centre distance between support profiles in mm	333	333
 Air cleaning power Activ'Air	✓	-
 Reaction to fire in accordance with DIN EN 14190	A2-s1, d0	A2-s1, d0

Practical sound absorption coefficient α_p
(Rigitone® Activ'Air®)



	α_w					NRC	Class
 Suspension height 30 mm, mineral wool layer 30 mm ¹⁾	0.20	0.55	0.75	0.85	0.80	0.75	B
 Suspension height 50 mm	0.15	0.25	0.60	0.85	0.65	0.55 (M)	D
 Suspension height 50 mm, mineral wool layer 50 mm (30+20) ¹⁾	0.40	0.70	0.80	0.75	0.80	0.75	B
 Suspension height 200 mm	0.40	0.65	0.80	0.60	0.55	0.60	C
 Suspension height 200 mm, mineral wool layer 50 mm (30+20) ¹⁾	0.60	0.75	0.75	0.80	0.80	0.80	B
 Suspension height 400 mm, mineral wool layer 50 mm (30+20) ¹⁾	0.65	0.60	0.70	0.85	0.85	0.80	B

¹⁾e.g. ISOVER Akustic SSP 1 or Ultimate TP-039

8/18 Q

**Rigitone® Activ'Air®,
Rigitone® Climafit®**

Regular square perforation

Width x length: 1,188 x 1,998 mm

Perforated area: 19.8%

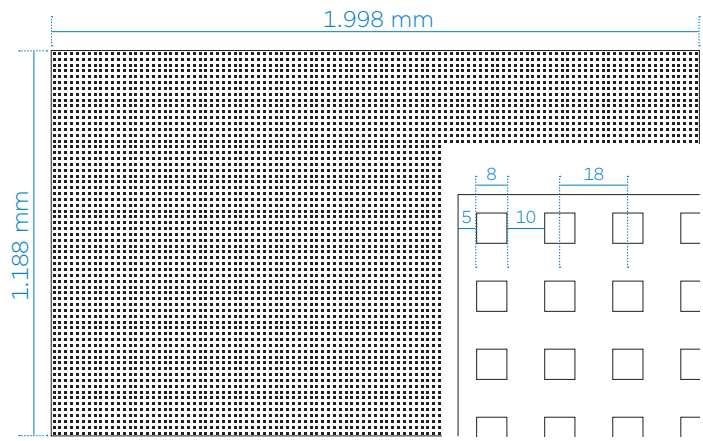
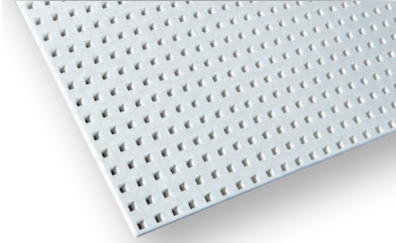
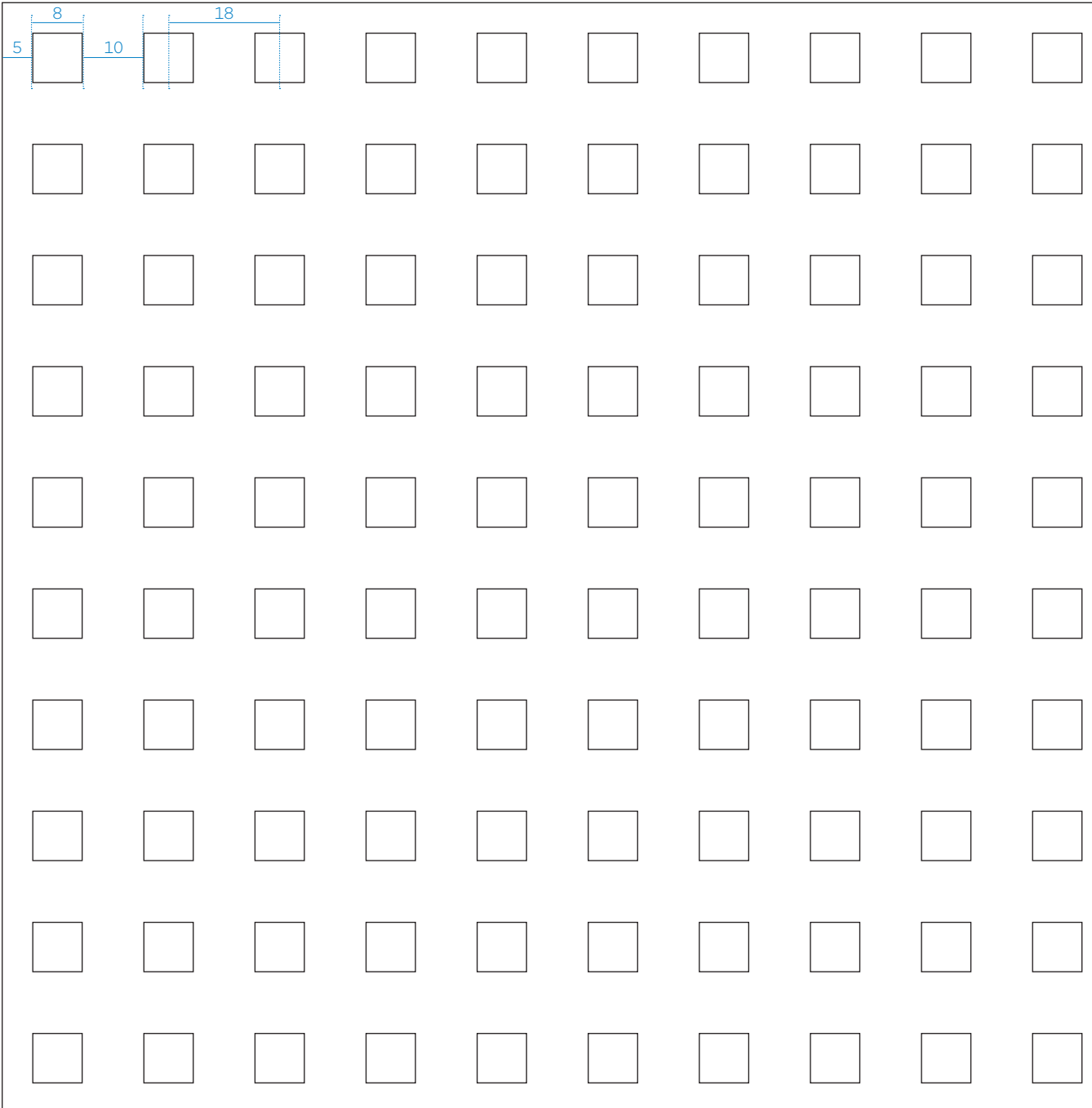









Diagram scale 1:1







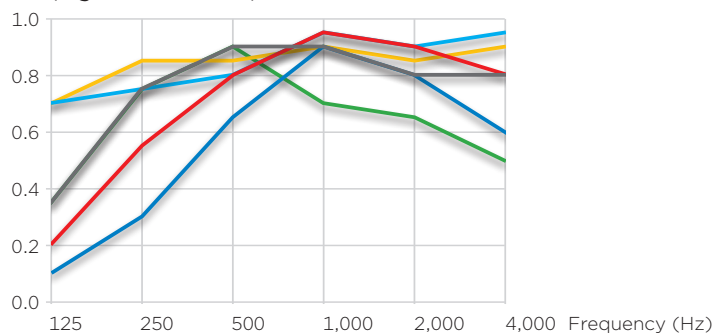

Rigitone® Activ'Air® and Rigitone® Climafit® 12/25 Q

	Rigitone® Activ'Air®	Rigitone® Climafit®
 System number	AD10RTA	
 Board thickness in mm	12.5	10
 Weight in kg/m ²	ca. 8.0	ca. 6.7
 Perforated area in %	23	23
 Centre-to-centre distance between support profiles in mm	333	333
 Air cleaning power Activ'Air	✓	-
 Reaction to fire in accordance with DIN EN 14190	A2-s1, d0	A2-s1, d0

Practical sound absorption coefficient α_p
(Rigitone® Activ'Air®)



	α_w	NRC	Class
 Suspension height 30 mm, mineral wool layer 30 mm ¹⁾	0.20 0.55 0.80 0.95 0.90 0.80	0.80	0.80 B
 Suspension height 50 mm	0.10 0.30 0.65 0.90 0.80 0.60	0.60 (M)	0.65 C
 Suspension height 50 mm, mineral wool layer 50 mm (30+20) ¹⁾	0.35 0.75 0.90 0.90 0.80 0.80	0.90	0.85 A
 Suspension height 200 mm	0.35 0.75 0.90 0.70 0.65 0.50	0.65 (LM)	0.70 C
 Suspension height 200 mm, mineral wool layer 50 mm (30+20) ¹⁾	0.70 0.85 0.85 0.90 0.85 0.90	0.90	0.90 A
 Suspension height 400 mm, mineral wool layer 50 mm (30+20) ¹⁾	0.70 0.75 0.80 0.95 0.90 0.95	0.90	0.85 A

¹⁾ e.g. ISOVER Akustic SSP 1 or Ultimate TP-039

12/25 Q

Rigitone® Activ'Air®,
Rigitone® Climafit®

Regular square perforation

Width x length: 1,200 x 2,000 mm

Perforated area: 23.0%

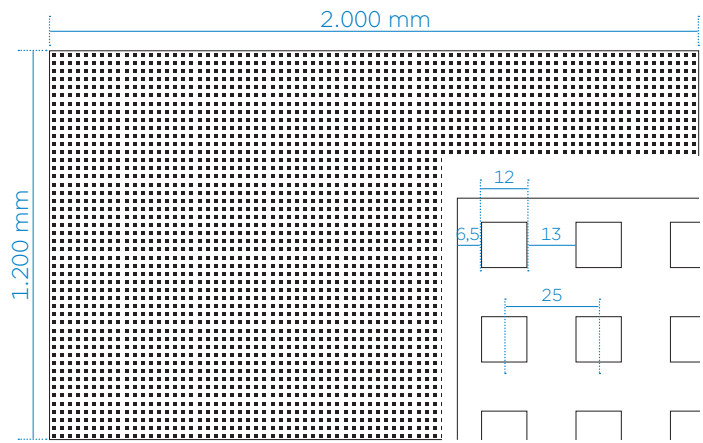
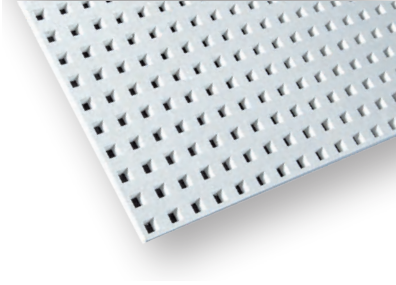

Diagram scale 1:1



Installation-information Rigitone® perforated ceilings

Substructure

The substructure – comprising base and support profiles (CD profiles) – should be mounted and aligned in such a way that the Rigitone boards can be fastened at right angles to the support profiles. A support profile must always be located at the transverse joints of the boards.

Fastening

Rigitone 3.5 x 30 mm perforated panel screws should be attached at intervals ≤ 170 mm; the Rigitone boards should be fastened along the short side first, then the long side.

Rigitone® perforated ceiling with border

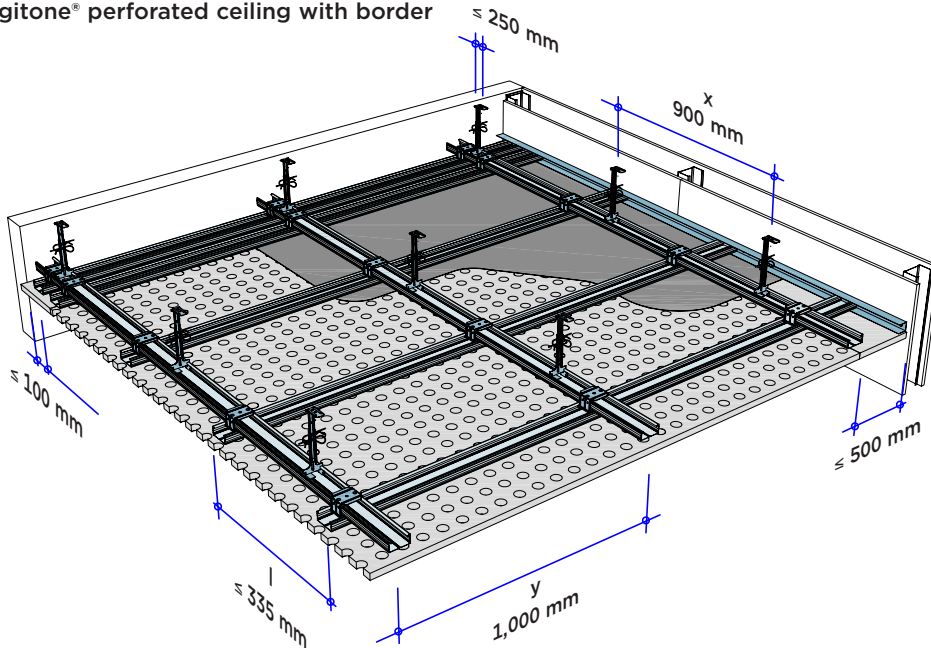

Centre-to-centre distance between support profiles as per the perforation pattern

Product	Centre-to-centre distance between support profiles mm
Rigitone 6/18 R	333
Rigitone 8/18 R	333
Rigitone 10/23 R	333
Rigitone 12/25 R	333
Rigitone 15/30 R	330
Rigitone 12-20/66 R	330
Rigitone 8-15-20 R	333
Rigitone 8-15-20 super R	327
Rigitone 12-20-35 R	333
Rigitone 8/18 Q	333
Rigitone 12/25 Q	333

Substructure spacing

Base profile RigiProfil® MultiTec	Hanger Spacing ¹⁾ Load class kN/m ²		Support profile RigiProfil® MultiTec
	up 0.15	to 0.30	
CD 60/27	x	x	l
y	mm	mm	mm
500	1,200	950	max 335
600	1,150	900	max 335
700	1,100	850	max 335
800	1,050	750	max 335
900	1,000	800 ¹⁾	max 335
1.000	900	750 ¹⁾	max 335
1.100	900	700 ¹⁾	max 335
1.200	900	650 ¹⁾	max 335

Note: Board weight + substructure + 20 mm mineral wool < 15 kg/m² (0.15 kN/m²). Additional layers will increase the total surface weight of the ceiling and may result in classification in the load class up to 0.30 kN/m².

¹⁾ Load capacity class of hanger: 0.40 kN/m²

Wall joints

To allow for structural tolerances, a non-perforated plasterboard strip should be installed around the edges. Rigitone perforated boards can also be supplied with non-perforated edges.

Filled joints using RigiProfil® MultiTec UD 28 joint profiles with border

Where a Rigitone perforated board ceiling meets a building wall which is to be plastered, Rigips TrennFix should be inserted before filling. This ensures neat separation of the different materials.

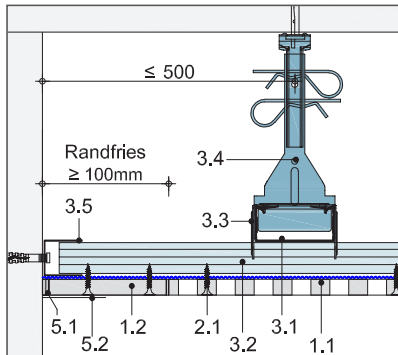

Short side

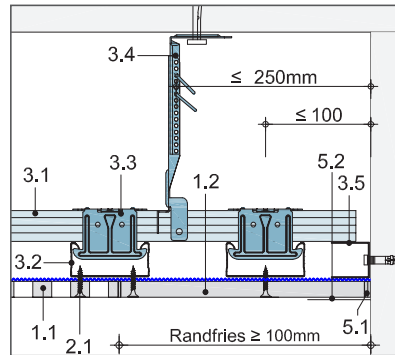

Long side

- 1.1 Rigitone perforated board
- 1.2 Border – Rigips RB construction board
- 2.1 Rigitone perforated panel screw
- 3.1 RigiProfil MultiTec CD 60/27 ceiling profile (base profile)
- 3.2 RigiProfil MultiTec CD 60/27 ceiling profile (supporting profile)
- 3.3 Rigips crossover fast connector
- 3.4 Rigips 400 N nonius hanger system
- 3.5 RigiProfil MultiTec UD 28 joint profile
- 5.1 Rigips joint filler
- 5.2 Rigips reinforcements strips or alternatively Rigips TrennFix tape in accordance with installation guidelines

i Information

Detailed information on the two different Joint Filling Techniques can be:



- Rigitone joint filling with VARIO Joint filler
- Rigitone joint filling technique with Rigitone Mix

Installation-information

Rigitone® perforated ceilings

Joints with a shadow gap

In the case of separated ceiling to wall joints, the gap between the support profiles and the wall should be max. 150 mm. A Rigips AquaBead L-Trim or a Rigips 13/25 end profile (“Goeppinger profile”) may also be embedded in the filler flush to the surface along the free board edges.

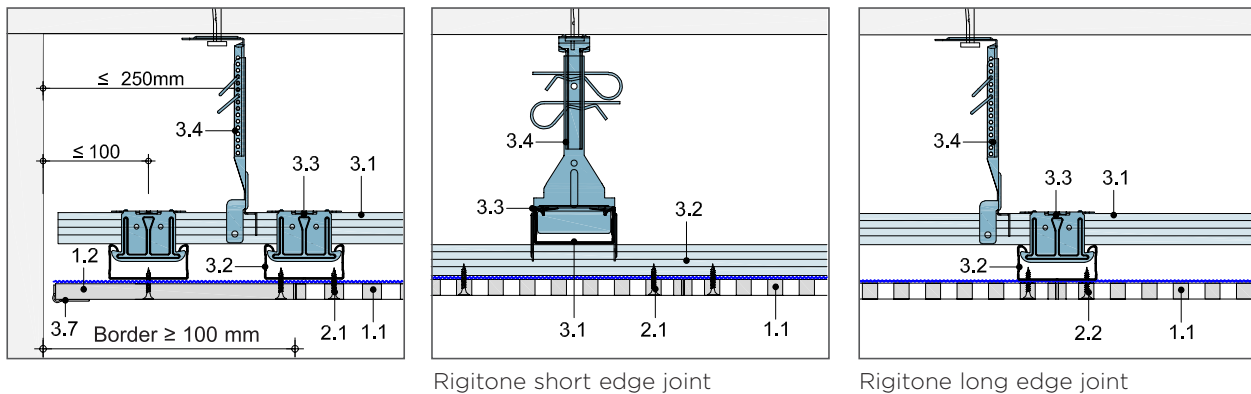

- 1.1 Rigitone perforated board
- 1.2 Border – Rigips RB construction board
- 2.1 Rigitone perforated panel screw
- 2.2 Rigitone perforated panel screw
- 3.1 RigiProfil MultiTec CD 60/27 ceiling profile (base profile)
- 3.2 RigiProfil MultiTec CD 60/27 ceiling profile (supporting profile)
- 3.3 Rigips crossover fast connector
- 3.4 Rigips 400 N nonius hanger system
- 3.7 Rigips AquaBead L-Trim or Rigips end profile 13/25 “Goeppinger profile”

Expansion and settlement joints

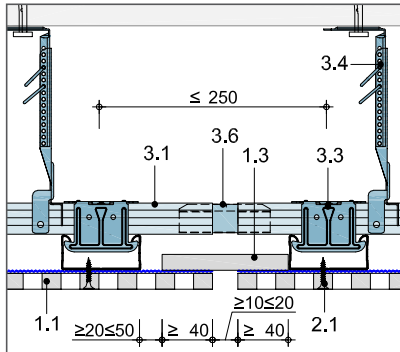

Cross section: Settlement joint with profile cover for Rigips acoustic ceilings

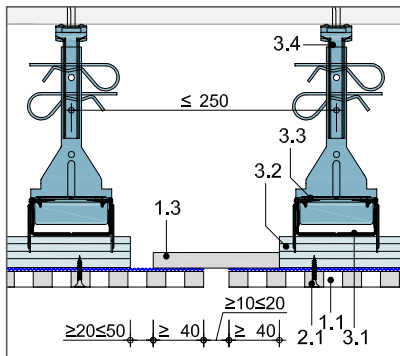

Longitudinal section: Settlement joint with profile cover for Rigips acoustic ceilings

- 1.1 Rigitone perforated board
- 1.3 Border - Rigips RB construction board
- 2.1 Rigitone perforated panel screw
- 3.1 RigiProfil MultiTec CD 60/27 ceiling profile (base profile)
- 3.2 RigiProfil MultiTec CD 60/27 ceiling profile (supporting profile)
- 3.3 Rigips crossover fast connector
- 3.4 Rigips 400 N nonius hanger system
- 3.6 Rigips ceiling profile connector

! Rigips Note!

Settlement joints in the building shell must be continued into the structure of the suspended ceiling. In general, expansion joints should also be spaced longitudinally and transversely at intervals of approx. 10 m. It is necessary to reduce the given side lengths where the free movement of the ceiling area is prevented and where long ceilings with relatively large integrated lighting systems (e.g. corridor ceilings) are installed. Layouts where the free movement of the ceiling area is prevented should be as follows:

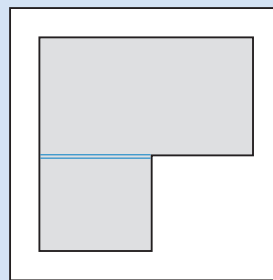

Re-entrant structural components

- Open expansion joint
- Sliding expansion joint (settlement joint necessary)

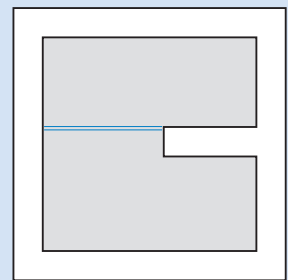

Re-entrant shear walls

- Open expansion joint or
- Sliding expansion joint (settlement joint necessary)

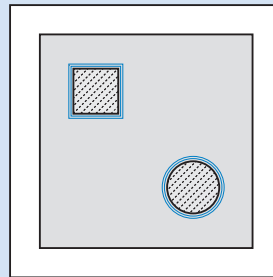

Suspended ceilings with cavities for supports

- Sliding joint necessary

Rigitone® sports hall ceilings

Rigitone sports hall ceilings – capable of taking everything thrown at them

When planning modern sports facilities, both functional and aesthetic requirements must be taken into account. “Impact resistance” is also a criterion here. Rigitone perforated ceilings can be supplied in “impact-resistant” versions in accordance with DIN 18032 Part 3 – this corresponds to test class 1A in DIN EN 13964 Annex D. Depending on the perforation pattern, the centre-to-centre distances between support profiles given in the table must be observed.

Substructure

Reducing the centre-to-centre distance between the support profiles ensures impact resistance.

Fastening

Rigitone SN 3.5 x 30 mm perforated panel screws should be attached at intervals of 170 mm. The Joint Filling Techniques can be used for Rigitone perforated ceilings.

Centre-to-centre distance between support profiles as per the perforation pattern

Product	Profile spacing
	200 mm
Rigitone Activ'Air 6/18 R	X
Rigitone Activ'Air 8/18 R	X
Rigitone Activ'Air 10/23 R	X
Rigitone Activ'Air 12-20-35 R	X
Rigitone Activ'Air 8-15-20 R	X
Rigitone Activ'Air 8-15-20 super R	X

Information



Detailed information on the two different Joint Filling Techniques can be:

- Rigitone joint filling with VARIO Joint filler
- Rigitone joint filling technique with Rigitone Mix

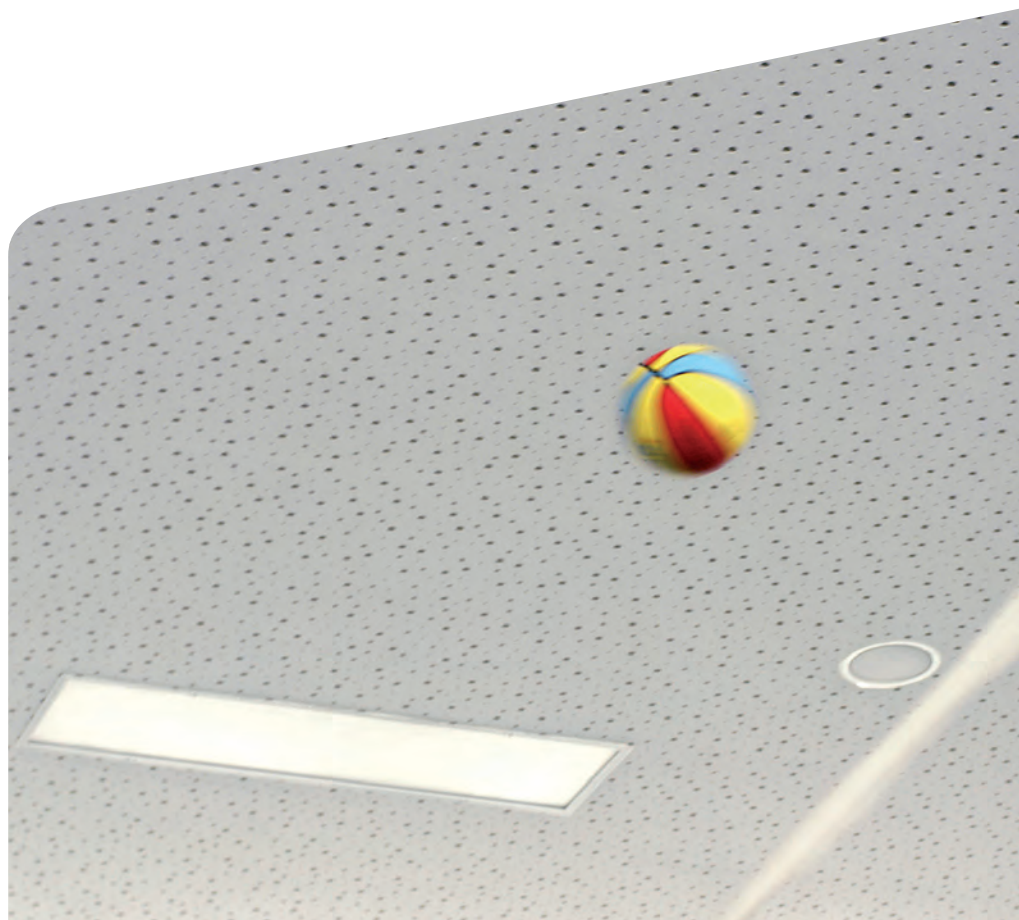

Rigitone® F 30 ceiling: Fire protection and acoustic

The tried and tested Rigitone F 30 ceiling offers a fire resistance of up to 30 minutes in the event of a fire, regardless of whether it comes from the area above the suspended ceiling or the room. This is a requirement for escape routes, e.g. in public buildings, hospitals, schools and administrative buildings. The need for accessibility for inspection purposes was also taken into account in the development of this Rigitone F 30 ceiling. The inspection flaps from Riegelhof & Gärtner (RUG) are fire-certified and allow access to installations in the ceiling cavity at all times.

Substructure

- Rigips direct fasteners for C ceiling profiles (running rails) are used to fasten the support profile to the base profile through the fireproof board.
- Alternatively, U direct hangers, ad-justable direct hangers or Rigips "Klick Fix" direct fasteners may be used.
- Where there is a risk of exposure to fire from below, the base profile should be attached to the slab using the CD 250 nonius hanger system. Where there is a risk of exposure to fire from above, the CD 400 nonius hanger system should be used. In the event of fire exposure from the area above the suspended ceiling, the slab must have a fire resistance class of at least F 30.
- The fireproof ceiling cannot absorb any additional loads from the ceiling cavity in the event of a fire.



Information

The acoustic properties of the Rigitone F 30 ceiling depend on the perforation design. The absorption values for the corresponding perforations with a 50 mm plenum depth and acoustic tissue may be taken as approximate values here.

Rigitone® F 30 ceiling: Fire protection and acoustic

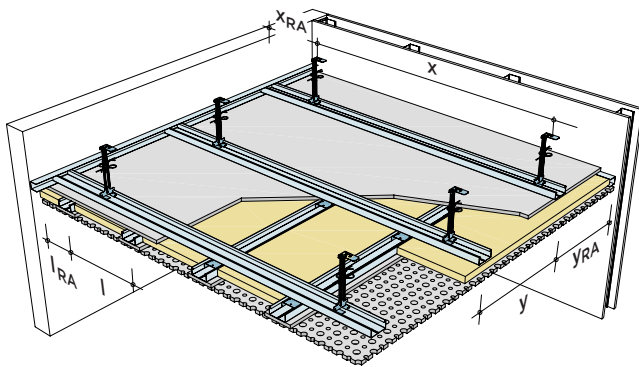

Substructure spacing

	Where the suspended ceiling is at risk of exposure to fire	
	from below	*from above
Hanger system	Nonius CD 250	Nonius CD 400
l Centre-to-centre distance between support profiles	≤ 320 mm	≤ 320 mm
x Hanger spacing	≤ 1.000 mm	≤ 850 mm
y Centre-to-centre distance between base profiles	≤ 500 mm	≤ 500 mm

* from the area above the suspended ceiling

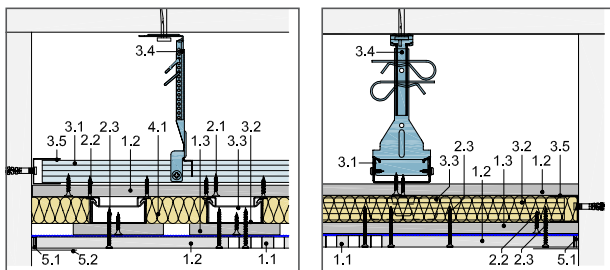

Joint to building wall with a border using a RigiProfil MultiTec UD 28

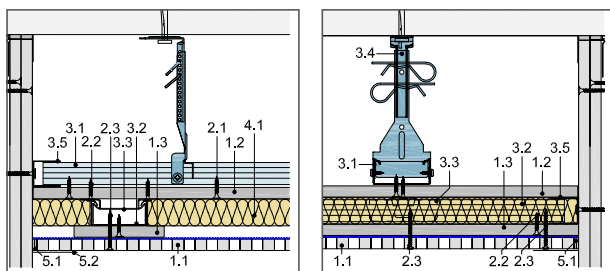

Joint to a RigiProfil panelled wall > F 30 without border

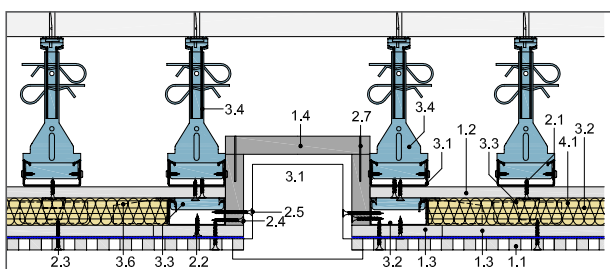

Integration of lighting elements

- 1.1 Rigitone perforated board
- 1.2 Rigips RF fireproof board,
- 1.3 Rigips RF fireproof board strip, d = 12.5 mm
b = 100 mm
- 1.4 Rigips Glasroc F 20 mm
- 2.1 Rigips drywall screw TN 3.5 x 25 mm, a = 170 mm
- 2.2 Rigips drywall screw TN 3.5 x 25 mm, a = 750 mm
- 2.3 Rigips drywall screw TN 3.5 x 35 mm, a = 170 mm
- 2.4 Rigips drywall screw TN 3.5 x 35 mm, a = 170 mm
- 2.5 Rigips drywall screw TN 3.5 x 45 mm
- 2.7 Steel wire clips - dimensions: 50/11.25/1.53 mm
- 3.1 RigiProfil MultiTec CD 60/27 ceiling profile (base profile)
- 3.2 RigiProfil MultiTec CD 60/27 ceiling profile (supporting profile)
- 3.3 Rigips "Klick Fix" direct fasteners
- 3.4 Rigips nonius hanger system load capacity class: 0.25 kN (risk of exposure to fire from the room) and load capacity class: 0.40 kN (risk of exposure to fire from the area above the suspended ceiling)
- 3.5 RigiProfil MultiTec UD 28
- 3.6 Rigips ceiling profile connector
- 3.7 Angles made from RigiProfil MultiTec CD 60/27 ceiling profiles (l = 150 mm)
- 4.1 Mineral wool, d ≥ 25 mm in accordance with DIN 18165 building material classification A, melting point ≥ 1,000 °C (e.g. Isover EP5)
- 5.1 Rigips joint filling
- 5.2 Rigips reinforcements strips or alternatively Rigips TrennFix tape in accordance with installation guidelines
- 6.1 inspection hatch RUG Semin GmbH
- 6.2 fire protection set

Wall joints

The joint between the wall and the Rigitone F 30 ceiling can be realised with or without a RigiProfil MultiTec UD 28 joint profile. The edge spacing for the substructure set out in the table (see right-hand side) must be observed.

Substructure edge gaps

Edge gaps	With joint profile	Without joint profile
I_{RA} Support profile (centre axis) <-> wall spacing	≤ 130 mm	≤ 130 mm
X_{RA} Hanger (centre axis) <-> wall spacing	≤ 1.000 mm (Fire from below) ≤ 850 mm (Fire from below)	≤ 250 mm
Y_{RA} Base profile (centre axis) <-> wall spacing	≤ 500 mm	≤ 250 mm

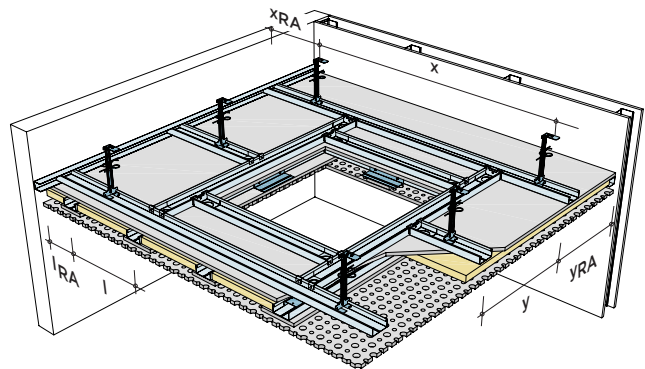

Inspection flap fastenings

Inspection flaps from Riegelhof & Gärtner (RUG) with inside dimensions of up to 600 x 600 mm may be integrated into a Rigitone F 30 ceiling. The entire surrounding metal substructure should be replaced with CD 60/27 ceiling profiles at the level of the base and support profiles. The replaced profiles should be fastened together and to the substructure using safety transverse connectors. The surrounding fireproof board strips and Rigitone boards should be joined to the frame at intervals of approx. 170 mm using Rigips TN 3.5 x 25 mm and TN 3.5 x 35 mm drywall screws.

i Information

To ensure a flawless perforation pattern, it is recommended that the perforated board section for the inspection flap cover is cut on site.

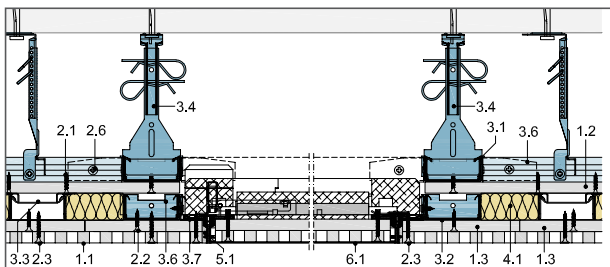

RUG AluProtect® F 30 inspection flap

The inspection flaps should be fastened to the suspended ceiling using Rigips TN 3.5 x 35 mm drywall screws at intervals of approx. 170 mm. The weight of the inspection flap is transferred to the substructure via four 150 mm long angles, one positioned at the centre of each side. These angles should be cut from a CD profile and screwed into the frame using with two 3.8 x 11 mm drywall screws for each one.

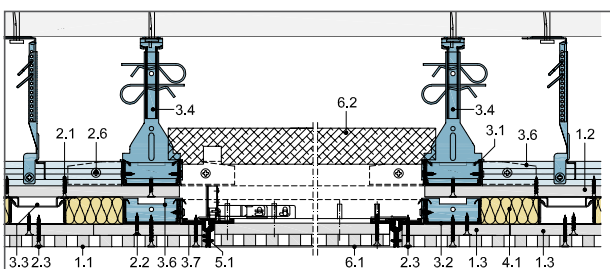

RUG Alumatic F 30 inspection flap

In order to protect the ceiling from exposure to fire from the area above the suspended ceiling (from above) the fire protection set supplied with the inspection flap must be installed. The Alumatic F 30 fire protection set made of mineral wool is only necessary in the event of fire exposure from above.

Temperature control ceilings: Cooling and heating systems

Optimum room temperature

Radiant cooling and heating systems offer the ideal combination of comfort and cost-effectiveness. They ensure a constant room temperature throughout the year. As they operate on the radiant principle, they heat and cool rooms gently. They are extremely efficient, save space and have many other advantages such as:

- No disruptive operating noises
- No air disturbance
- No unpleasant draughts
- No spreading of dust particles and bacteria

They offer the benefit of low flow temperatures, e.g. if a temperature-control ceiling is used for heating, flow temperatures of approx. 30 °C are sufficient and if it is used as a cooling ceiling, the desired effect can already be achieved at temperatures of approx. 16 °C. These low flow temperatures enable the use of alternative, eco-friendly energy sources such as heat pumps, solar systems, etc.

The effectiveness of temperature-control ceilings is strongly dependent on their panelling. The more efficiently the generated heat or coldness is transmitted, the less energy and material needs to be used to achieve a specific temperature effect.



Cooling system with Rigitone Climafit 8/18 R

Temperature control ceilings: Cooling and heating systems

Rigips Climafit - best choice for panelling of cooling and heating systems

Climafit boards are the premium products for state-of-the-art cooling and heating systems – they are special plasterboards with a gypsum core containing graphite. Climafit combines the outstanding residential construction qualities of a plasterboard ceiling with the temperature control performance of a metal ceiling, offering natural comfort while realising highly efficient temperature control.

Rigitone Climafit boards have a unique thermal conductivity level of $0.52 \text{ W}/(\text{m} \cdot \text{K})$ in accordance with DIN EN 12664. This increases the efficiency of the temperature control effect in the magnitude of 15 - 35% (in watts). Climafit ceiling boards also offer the familiar advantages of Rigips boards: they are easy to install, highly flexible, tested for building biology aspects, clean and environmentally friendly.

i Rigips Climafit-Information

The secret of the extraordinary thermal conductivity of Rigips Climafit boards lies in their gypsum core: it contains a graphite granulate – a construction material made of flaked natural graphite. This is a naturally occurring mineral and – like diamond – is an inorganic modification of carbon. It is completely safe to use, non-combustible, highly chemically and thermally resistant, and extraordinarily conductive. The graphite volume is enlarged/expanded

up to 400 times in the manufacturing process, resulting in a significant weight reduction while its inherent excellent level of thermal conductivity is retained. The graphite granulate produced in this way, with a thermal conductivity coefficient similar to that of aluminium, is then integrated into the highly thermally conductive Climafit plasterboards.



Gypsum crystal

- Natural raw material
- Recommended in terms of building biology
- Regulates indoor climate
- Versatile
- Non-combustible

+



Graphite crystal

- Natural product
- Thermally conductive
- Light
- Non-combustible
- Flexible

=



Rigips Climafit with a gypsum-graphite core: $\lambda = 0,52 \text{ W}/(\text{m} \cdot \text{K})$

! Rigips Note!

Rigitone Climafit needs to be fixed with Rigips Climafit drywall screws 23.



These screws were especially designed for mounting of Climafit perforated boards to metal sub-structures and offer adequate corrosion resistance. Only these screws offer long term and safe usability of the system.

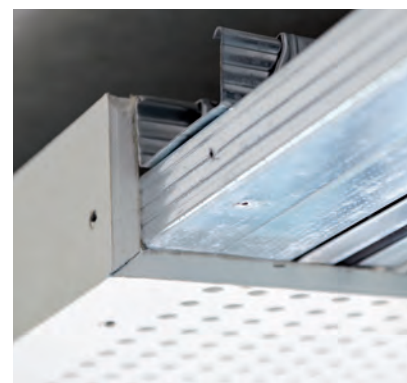



In addition to the outstanding climate regulation effect of the Climafit boards, the visual aspects of the Rigitone Climafit boards are a further advantage. In addition to the broad range of different perforation patterns available, they also possess special acoustic properties – the perfect symbiosis of aesthetic room ambience and optimum indoor climate.



Installation information

- Please note that the acoustic may vary depending on the cooling ceiling system used.
- For non-perforated Climafit boards, the substructure span must be ≤ 400 mm.
- The substructure is always a component of the climate control technology.
- The structure of the panel temperature control system varies depending on the manufacturer. The manufacturer specifications must therefore be observed during installation.
- Settlement joints in the building shell must be continued into the structure of the suspended ceiling. In general, expansion joints should also be spaced longitudinally and transversely at intervals of approx. 7.5 m. It is necessary to reduce the given side lengths where the free movement of the ceiling area is prevented or where long ceilings with relatively large integrated lighting systems (e.g. corridor ceilings) are installed.



Rigips® - The Original. For space to live.



More comfort for everyone

Every day we spend up to 90% of our time inside rooms. That's why we at Rigips believe that well-designed rooms make a key contribution to our well-being. So we develop forward-looking, sustainable interior solutions aimed at maximizing user comfort for all requirements and living situations.



Forward-looking construction

As a trailblazing pioneer and synonym for drywall construction in Germany, Rigips has constantly developed this method since the company was established - through many diverse innovations and high-quality system solutions. Our goal is to develop solutions today that are already oriented to the challenges of tomorrow to enable forward-looking building and room design.



Simple and safe solutions

Our developments focus on reliable, safe systems which meet the constantly rising and ever more sophisticated requirements involved in construction. With our proven systems we make an important contribution to improved planning and processing reliability, as well as greater efficiency and cost-effectiveness in drywall construction.



Sustainable living spaces for generations

Rigips stands for the manufacture of particularly eco-friendly construction materials from the natural raw material gypsum. We are highly committed to sustainable construction. For us this also means improving comfort and quality of life for people and the value of their living spaces. From generation to generation.





© Saint-Gobain Rigips GmbH

1st edition, July 2021

The information given in this document corresponds to the following: State of our knowledge and experience at Printing (cf. Printing endorsement). Unless expressly agreed otherwise, however, they do not constitute a guarantee in the legal sense. The state of knowledge and experience is constantly evolving.

Therefore, please make sure to use the latest edition of this publication (www.rigitone.com).

The described product applications cannot take into account special circumstances of the individual case. Therefore, check our products for their suitability for the specific purpose of application. If you have any questions, please contact your partners in place of production.

Headquarters

Saint-Gobain Rigips GmbH

Schanzenstraße 84
40549 Duesseldorf
Germany

Climafit®, Die Dicke von Rigips®, Rifino®, Rifix®, Rigidur®, Rigidur®, RigiProfil®, Rigips®, RigipsProfi®, RigiRaum®, RigiSystem®, RigiTherm®, Rigitone®, Rikombi®, Rimat®, RiStuck® and VARIO® are registered brands of Saint-Gobain Rigips GmbH. Activ'Air®, AquaBead®, Aquaroc®, Glasroc®, Gyptone®, Habito® and Levelline® are registered brands of Compagnie de Saint-Gobain.

rigitone.com



Headquarters

Saint-Gobain Rigips GmbH
Schanzenstraße 84
40549 Duesseldorf
Germany

Phone +49(0)211 5503-0
Fax +49(0)211 5503-208

info@rigips.de
www.rigips.de