

Installation guidelines  
Room acoustic  
**Walls and ceilings  
with Rigitone® boards**



## Rigips® – The Original. For space to live.



### More comfort for everyone

Every day we spend up to 90% of our time inside rooms. That's why we at Rigips believe that well-designed rooms make a key contribution to our well-being. So we develop forward-looking, sustainable interior solutions aimed at maximizing user comfort for all requirements and living situations.



### Forward-looking construction

As a trailblazing pioneer and synonym for drywall construction in Germany, Rigips has constantly developed this method since the company was established – through many diverse innovations and high-quality system solutions. Our goal is to develop solutions today that are already oriented to the challenges of tomorrow to enable forward-looking building and room design.



### Simple and safe solutions

Our developments focus on reliable, safe systems which meet the constantly rising and ever more sophisticated requirements involved in construction. With our proven systems we make an important contribution to improved planning and processing reliability, as well as greater efficiency and cost-effectiveness in drywall construction.



### Sustainable living spaces for generations

Rigips stands for the manufacture of particularly eco-friendly construction materials from the natural raw material gypsum. We are highly committed to sustainable construction. For us this also means improving comfort and quality of life for people and the value of their living spaces. From generation to generation.

|            |   |              |
|------------|---|--------------|
| <b>1.</b>  | <b>Board overviews</b>  | <b>3-9</b>   |
| <b>1.1</b> | <b>Rigitone Activ'Air boards / Rigitone Climafit</b>                                      | <b>4</b>     |
| 1.1.1      | Rigitone Activ'Air boards / Rigitone Climafit with round, regular perforation             | 4            |
| 1.1.2      | Rigitone Activ'Air boards with round, regularly staggered perforation                     | 6            |
| 1.1.3      | Rigitone Activ'Air boards / Rigitone Climafit with round, irregular scattered perforation | 6            |
| 1.1.4      | Rigitone Activ'Air boards / Rigitone Climafit with square, regular perforation            | 8            |
| <b>2.</b>  | <b>Board storage, transportation, processing</b>  | <b>11-14</b> |
| <b>2.1</b> | <b>Board storage</b>  | <b>12</b>    |
| <b>2.2</b> | <b>Board transportation</b>   | <b>12</b>    |
| 2.2.1      | Large boards  | 12           |
| <b>2.3</b> | <b>Board processing</b>   | <b>13</b>    |
| 2.3.1      | Optimum edges   | 14           |
| 2.3.2      | Board cut-outs  | 14           |
| <b>3.</b>  | <b>Construction site conditions</b>   | <b>15-17</b> |
| <b>3.1</b> | <b>General construction site conditions</b>   | <b>16</b>    |
| <b>3.2</b> | <b>Winter construction</b>  | <b>17</b>    |
| <b>4.</b>  | <b>Rigitone ceiling systems</b>   | <b>19-43</b> |
| <b>4.1</b> | <b>General requirements</b>   | <b>20</b>    |
| 4.1.1      | Expansion and settlement joints   | 21           |
| <b>4.2</b> | <b>Suspended Rigitone perforated ceiling</b>  | <b>22</b>    |
| <b>4.3</b> | <b>Impact-resistant Rigitone sports hall ceilings</b>                                     | <b>30</b>    |
| <b>4.4</b> | <b>Rigitone F 30 ceiling</b>  | <b>32</b>    |
| 4.4.1      | Installation of lighting and inspection hatches   | 36           |
| <b>4.5</b> | <b>Cooling and heating systems using Rigitone Climafit boards</b>                         | <b>41</b>    |
| <b>5.</b>  | <b>Joint techniques</b>   | <b>45-53</b> |
| <b>5.1</b> | <b>Joint techniques for Rigitone ceilings</b>   | <b>46</b>    |
| 5.1.1      | Joint Filling Technique using the Rigitone Fix Joint Filling Set and VARIO joint filler   | 46           |
| 5.1.2      | Joint Filling Technique using the Rigips ReadyMix Set and Rigitone Mix ready filler       | 50           |

|           |  |              |
|-----------|--|--------------|
| <b>6.</b> | <b>Wall absorbers</b>                                | <b>55-63</b> |
| 6.1       | Wall facings   | 56           |
| 6.2       | Freestanding wall facing in front of a building wall | 59           |
| 6.3       | Rigitone wall  | 62           |
| <b>7.</b> | <b>Load fastening / coatings</b>                     | <b>65-67</b> |
| 7.1       | Loads on ceilings (with perforation)                 | 66           |
| 7.1.1     | Installations in Rigitone perforated ceilings        | 66           |
| 7.2       | Cavity dowels for ceiling structures                 | 67           |
| 7.3       | Final coating of Rigitone boards                     | 67           |

# 1 Board overviews

## Chapter contents

|            |   |          |
|------------|---|----------|
| <b>1.1</b> | <b>Rigitone Activ'Air boards / Rigitone Climafit</b>                                      | <b>4</b> |
| 1.1.1      | Rigitone Activ'Air boards / Rigitone Climafit with round, regular perforation             | 4        |
| 1.1.2      | Rigitone Activ'Air boards with round, regularly staggered perforation                     | 6        |
| 1.1.3      | Rigitone Activ'Air boards / Rigitone Climafit with round, irregular scattered perforation | 6        |
| 1.1.4      | Rigitone Activ'Air boards / Rigitone Climafit with square, regular perforation            | 8        |

## 1.1 Rigitone Activ'Air boards<sup>1)</sup>/Rigitone Climafit<sup>3)</sup>

### 1.1.1 Rigitone Activ'Air boards<sup>1)</sup>/Rigitone Climafit<sup>3)</sup> with round, regular perforation

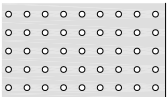
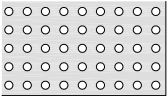
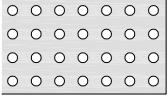
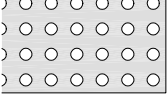
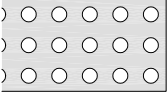
| System sketch/no.<br><b>AD10RTA</b>  | Perforated board<br>System name/<br>edge  | Perforation<br>diameter<br>mm | Distance<br>between<br>perforations<br>mm | Perforated<br>areal<br>% | Board dimensions |              |                      | Sound absorption      |            |                            | Reaction to fire<br>In acc. with<br>DIN EN 14190 |
|--|---|-------------------------------|---|--------------------------|------------------|--------------|----------------------|-----------------------|------------|----------------------------|--|
|  |   |                               |   |                          | Width<br>mm      | Length<br>mm | Thick-<br>ness<br>mm | Plenum<br>depth<br>mm | $\alpha_w$ | Sound<br>absorber<br>class |  |
|    | <b>Rigitone Activ'Air<br/>6/18 R<sup>3)</sup></b><br><b>Rigitone Climafit<br/>6/18 R<sup>4)</sup></b><br>4 SK | 6                             | 18  | 8.7                      | 1,188            | 1,998        | 12.5                 | 30 <sup>2)</sup>      | 0.55       | D                          | A2-s1,d0 (C.4)                                   |
|  |   |                               |   |                          |                  |              |                      | 50                    | 0.55       | D                          |  |
|  |   |                               |   |                          |                  |              |                      | 50 <sup>3)</sup>      | 0.55       | D                          |  |
|  |   |                               |   |                          |                  |              |                      | 200                   | 0.45 (LM)  | D                          |  |
|  |   |                               |   |                          |                  |              |                      | 200 <sup>3)</sup>     | 0.55       | D                          |  |
| 400 <sup>3)</sup>  | 0.60  | C                             |   |                          |                  |              |                      |                       |            |                            |  |
|    | <b>Rigitone Activ'Air<br/>8/18 R<sup>3)</sup></b><br><b>Rigitone Climafit<br/>8/18 R<sup>4)</sup></b><br>4 SK | 8                             | 18  | 15.5                     | 1,188            | 1,998        | 12.5                 | 30 <sup>2)</sup>      | 0.75       | C                          | A2-s1,d0 (C.4)                                   |
|  |   |                               |   |                          |                  |              |                      | 50                    | 0.55 (M)   | D                          |  |
|  |   |                               |   |                          |                  |              |                      | 50 <sup>3)</sup>      | 0.75       | C                          |  |
|  |   |                               |   |                          |                  |              |                      | 200                   | 0.60       | C                          |  |
|  |   |                               |   |                          |                  |              |                      | 200 <sup>3)</sup>     | 0.75       | C                          |  |
| 400 <sup>3)</sup>  | 0.75  | C                             |   |                          |                  |              |                      |                       |            |                            |  |
|    | <b>Rigitone Activ'Air<br/>10/23 R<sup>3)</sup></b><br>4 SK  | 10                            | 23  | 14.8                     | 1,196            | 2,001        | 12.5                 | 30 <sup>2)</sup>      | 0.75       | C                          | A2-s1,d0 (C.4)                                   |
|  |   |                               |   |                          |                  |              |                      | 50                    | 0.45 (M)   | D                          |  |
|  |   |                               |   |                          |                  |              |                      | 50 <sup>3)</sup>      | 0.70       | C                          |  |
|  |   |                               |   |                          |                  |              |                      | 200                   | 0.50 (LM)  | D                          |  |
|  |   |                               |   |                          |                  |              |                      | 200 <sup>3)</sup>     | 0.70 (L)   | C                          |  |
| 400 <sup>3)</sup>  | 0.75  | C                             |   |                          |                  |              |                      |                       |            |                            |  |
|   | <b>Rigitone Activ'Air<br/>12/25 R<sup>3)</sup></b><br>4 SK  | 12                            | 25  | 18.1                     | 1,200            | 2,000        | 12.5                 | 30 <sup>2)</sup>      | 0.80       | B                          | A2-s1,d0 (C.4)                                   |
|  |   |                               |   |                          |                  |              |                      | 50                    | 0.55 (M)   | D                          |  |
|  |   |                               |   |                          |                  |              |                      | 50 <sup>3)</sup>      | 0.80       | B                          |  |
|  |   |                               |   |                          |                  |              |                      | 200                   | 0.55 (LM)  | D                          |  |
|  |   |                               |   |                          |                  |              |                      | 200 <sup>3)</sup>     | 0.80       | B                          |  |
| 400 <sup>3)</sup>  | 0.80  | B                             |   |                          |                  |              |                      |                       |            |                            |  |
|  | <b>Rigitone Activ'Air<br/>15/30 R<sup>3)</sup></b><br>4 SK  | 15                            | 30  | 19.6                     | 1,200            | 1,980        | 12.5                 | 30 <sup>2)</sup>      | 0.80       | B                          | A2-s1,d0 (C.4)                                   |
|  |   |                               |   |                          |                  |              |                      | 50                    | 0.45 (M)   | D                          |  |
|  |   |                               |   |                          |                  |              |                      | 50 <sup>3)</sup>      | 0.85       | B                          |  |
|  |   |                               |   |                          |                  |              |                      | 200                   | 0.50 (LM)  | D                          |  |
|  |   |                               |   |                          |                  |              |                      | 200 <sup>3)</sup>     | 0.80       | B                          |  |
| 400 <sup>3)</sup>  | 0.85  | B                             |   |                          |                  |              |                      |                       |            |                            |  |

<sup>1)</sup> Perforated plasterboards with air cleaning power

<sup>2)</sup> With a 30 mm mineral wool layer, e.g. Isover Akustic SSP 1 or Ultimate TP-039

<sup>3)</sup> With a 50 (30+20) mm mineral wool layer, e.g. Isover Akustic SSP 1 or Ultimate TP-039

<sup>4)</sup> Rigitone Climafit perforated plasterboards with graphite

#### Rigits-Information

Please find more information about Rigitone Activ'Air  
[www.rigitone.com](http://www.rigitone.com)

### 1.1.2 Rigitone Activ'Air boards<sup>1)</sup> with round, regularly staggered perforation

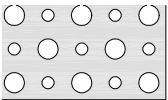

| System sketch/no.<br><b>AD10RTA</b>  | Perforated board<br>System name/<br>edge                      | Perforation<br>diameter<br>mm | Distance<br>between<br>perforations<br>mm | Perforated<br>areal<br>% | Board dimensions |              |                      | Sound absorption  |   |                            | Reaction to fire<br>In acc. with<br>DIN EN 14190 |
|--|---|-------------------------------|---|--------------------------|------------------|--------------|----------------------|---|---|----------------------------|--|
|  |   |                               |   |                          | Width<br>mm      | Length<br>mm | Thick-<br>ness<br>mm | Plenum<br>depth<br>mm   | $\alpha_w$  | Sound<br>absorber<br>class |  |
|  | <b>Rigitone Activ'Air<br/>12-20/66 R<sup>1)</sup></b><br>4 SK | 12/20                         | 66  | 19.6                     | 1,188            | 1,980        | 12.5                 | 30 <sup>2)</sup><br>50<br>50 <sup>3)</sup><br>200<br>200 <sup>3)</sup><br>400 <sup>3)</sup> | 0.80<br>0.45 (M)<br>0.80<br>0.50 (LM)<br>0.80<br>0.80 | B<br>D<br>B<br>D<br>B<br>B | A2-s1,d0 (C.4)                                   |

<sup>1)</sup> Perforated plasterboards with air cleaning power

<sup>2)</sup> With a 30 mm mineral wool layer, e.g. Isover Akustic SSP 1 or Ultimate TP-039

<sup>3)</sup> With a 50 (30+20) mm mineral wool layer, e.g. Isover Akustic SSP 1 or Ultimate TP-039

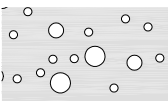
### 1.1.3 Rigitone Activ'Air boards<sup>1)</sup> / Rigitone Climafit<sup>4)</sup> with round, irregular scattered perforation

| System sketch/no.<br><b>AD10RTA</b>  | Perforated board<br>System name/<br>edge  | Perforation<br>diameter<br>mm | Distance<br>between<br>perforations<br>mm | Perforated<br>areal<br>% | Board dimensions |              |                      | Sound absorption  |  |                            | Reaction to fire<br>In acc. with<br>DIN EN 14190 |
|--|---|-------------------------------|---|--------------------------|------------------|--------------|----------------------|---|--|----------------------------|--|
|  |   |                               |   |                          | Width<br>mm      | Length<br>mm | Thick-<br>ness<br>mm | Plenum<br>depth<br>mm   | $\alpha_w$   | Sound<br>absorber<br>class |  |
|    | <b>Rigitone Activ'Air<br/>8-15-20 R<sup>1)</sup></b><br>4 SK  | 8/15/20                       | -   | 6.0                      | 1,200            | 2,000        | 12.5                 | 30 <sup>2)</sup><br>50<br>50 <sup>3)</sup><br>200<br>200 <sup>3)</sup><br>400 <sup>3)</sup> | 0.45<br>0.25 (LM)<br>0.40 (L)<br>0.30 (LM)<br>0.45<br>0.45 | D<br>E<br>D<br>D<br>D<br>D | A2-s1,d0 (C.4)                                   |
|  | <b>Rigitone Activ'Air<br/>8-15-20 super R<sup>1)</sup></b><br><b>Rigitone Climafit<br/>8-15-20 super R<sup>4)</sup></b><br>4 SK | 8/15/20                       | -   | 10.0                     | 1,200            | 1,960        | 12.5                 | 30 <sup>2)</sup><br>50<br>50 <sup>3)</sup><br>200<br>200 <sup>3)</sup><br>400 <sup>3)</sup> | 0.60<br>0.50 (M)<br>0.55<br>0.45 (LM)<br>0.60<br>0.65      | C<br>D<br>D<br>D<br>C<br>C | A2-s1,d0 (C.4)                                   |
|  | <b>Rigitone Activ'Air<br/>12-20-35 R<sup>1)</sup></b><br>4 SK   | 12/20/35                      | -   | 11.0                     | 1,200            | 2,000        | 12.5                 | 30 <sup>2)</sup><br>50<br>50 <sup>3)</sup><br>200<br>200 <sup>3)</sup><br>400 <sup>3)</sup> | 0.55<br>0.45<br>0.55 (L)<br>0.45 (L)<br>0.55 (L)<br>0.55   | D<br>D<br>D<br>D<br>D<br>D | A2-s1,d0 (C.4)                                   |

<sup>1)</sup> Perforated plasterboards with air cleaning power

<sup>2)</sup> With a 30 mm mineral wool layer, e.g. Isover Akustic SSP 1 or Ultimate TP-039

<sup>3)</sup> With a 50 (30+20) mm mineral wool layer, e.g. Isover Akustic SSP 1 or Ultimate TP-039

<sup>4)</sup> Rigitone Climafit perforated plasterboards with graphite

### 1.1.4 Rigitone Activ'Air boards<sup>1)</sup>/ Rigitone Climafit<sup>4)</sup> with square, regular perforation

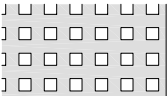
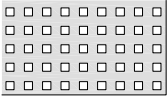
| System sketch/no.<br><b>AD10RTA</b>  | Perforated board<br>System name/<br>edge  | Perforation<br>diameter<br>mm | Distance<br>between<br>perforations<br>mm | Perforated<br>areal<br>% | Board dimensions |              |                      | Sound absorption      |            |                            | Reaction to fire<br>In acc. with<br>DIN EN 14190 |
|--|---|-------------------------------|---|--------------------------|------------------|--------------|----------------------|-----------------------|------------|----------------------------|--|
|  |   |                               |   |                          | Width<br>mm      | Length<br>mm | Thick-<br>ness<br>mm | Plenum<br>depth<br>mm | $\alpha_w$ | Sound<br>absorber<br>class |  |
|  | <b>Rigitone Activ'Air<br/>8/18 Q<sup>1)</sup></b><br><b>Rigitone Climafit<br/>8/18 Q<sup>4)</sup></b><br>4 SK   | 8 x 8                         | 18  | 19.8                     | 1,188            | 1,998        | 12.5                 | 30 <sup>2)</sup>      | 0.80       | B                          | A2-s1,d0 (C.4)                                   |
|  |   |                               |   |                          |                  |              |                      | 50                    | 0.55 (M)   | D                          |  |
|  |   |                               |   |                          |                  |              |                      | 50 <sup>3)</sup>      | 0.80       | B                          |  |
|  |   |                               |   |                          |                  |              |                      | 200                   | 0.60       | C                          |  |
|  |   |                               |   |                          |                  |              |                      | 200 <sup>3)</sup>     | 0.80       | B                          |  |
| 400 <sup>3)</sup>  | 0.80  | B                             |   |                          |                  |              |                      |                       |            |                            |  |
|  | <b>Rigitone Activ'Air<br/>12/25 Q<sup>1)</sup></b><br><b>Rigitone Climafit<br/>12/25 Q<sup>4)</sup></b><br>4 SK | 12 x 12                       | 25  | 23.0                     | 1,200            | 2,000        | 12.5                 | 30 <sup>2)</sup>      | 0.80       | B                          | A2-s1,d0 (C.4)                                   |
|  |   |                               |   |                          |                  |              |                      | 50                    | 0.60 (M)   | C                          |  |
|  |   |                               |   |                          |                  |              |                      | 50 <sup>3)</sup>      | 0.90       | A                          |  |
|  |   |                               |   |                          |                  |              |                      | 200                   | 0.65 (LM)  | C                          |  |
|  |   |                               |   |                          |                  |              |                      | 200 <sup>3)</sup>     | 0.90       | A                          |  |
| 400 <sup>3)</sup>  | 0.90  | A                             |   |                          |                  |              |                      |                       |            |                            |  |

<sup>1)</sup> Perforated plasterboards with air cleaning power

<sup>2)</sup> With a 30 mm mineral wool layer, e.g. Isover Akustic SSP 1 or Ultimate TP-039

<sup>3)</sup> With a 50 (30+20) mm mineral wool layer, e.g. Isover Akustic SSP 1 or Ultimate TP-039

<sup>4)</sup> Rigitone Climafit perforated plasterboards with graphite

**Chapter contents**

|            |                             |           |
|------------|-----------------------------|-----------|
| <b>2.1</b> | <b>Board storage</b>        | <b>12</b> |
| <b>2.2</b> | <b>Board transportation</b> | <b>12</b> |
| 2.2.1      | Large boards                | 12        |
| <b>2.3</b> | <b>Board processing</b>     | <b>13</b> |
| 2.3.1      | Optimum edges               | 14        |
| 2.3.2      | Board cut-outs              | 14        |

To ensure the high quality of the Rigips ceiling panel range is retained throughout, it is important to observe the following conditions.

## 2.1 Board storage

- The boards must be laid horizontally on a flat surface (pallet) or on scantlings at intervals of max. 350 mm **1**.
- The load-bearing capacity of the substrate must be taken into account when selecting board storage locations as e.g. 20 Rigitone Activ'Air 6/18 boards represent a load of approx. 5.50 kN/m<sup>2</sup> (550 kg/m<sup>2</sup> or 0.550 t/m<sup>2</sup>) on a surface. More detailed information can be found in the plasterboard industrial group (IGG) guideline no. 1 "Construction site conditions".

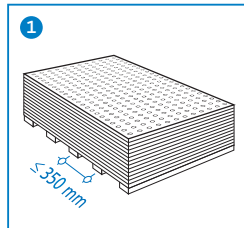

Correct horizontal storage of Rigitone boards

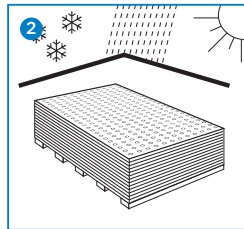

Protect Rigitone boards from moisture and weather

### ! Notes

- The boards and accessories must be protected from moisture and weather influences, also e.g. from sunlight **2**.
- Plasterboards which have become damp must be laid on a flat surface and allowed to dry completely before installation.
- We generally recommend storing plasterboards and joint filler in a dry indoor location.

## 2.2 Board transportation

### 2.2.1 Large boards

- When transporting boards using forklift trucks, the gap between the prongs must be at least 1 m.
- Rigitone boards should be transported in a vertical position or using suitable means of transportation (pallet truck or panel transporter) **3**.

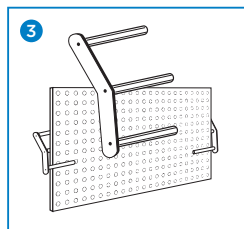

Panel transporter for easier vertical carrying

## 2.3 Board processing

- Shallow cuts should be made in the Rigitone boards using a cutter. When cutting boards, they should be laid on a flat surface such as a stack of other boards or a cutting table **4**.
- Cut into the paperboard on the front (use a straightedge), turn the board over, break the gypsum core and cut through the paperboard and acoustic tissue on the reverse **5**.
- Particularly precise cuts can be achieved using a fine-toothed hand saw or circular hand saw.
- Cut edges have to be pre-sanded and primed. Rikombi Grund should be used as priming coat. The recommended mixing ratio is 1:2.

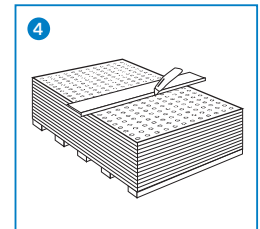

Cut into the paperboard on the front

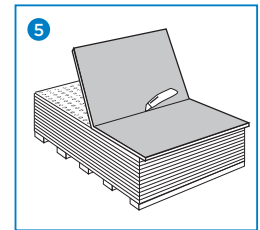

Cut through the reverse of the board

### ! Note

Rigitone boards must be lifted from the stack rather than dragged to prevent damage to the acoustic tissue.

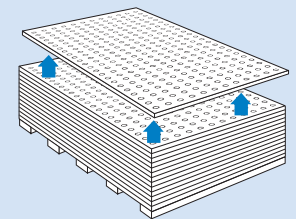



### 2.3.1 Optimum edges

- Rigitone boards are ready to install because of its pre-sanded and primed edges at factory site 1.
- Cut edges have to be pre-sanded and primed. Rikombi Grund should be used as priming coat. The recommended mixing ratio is 1:2.

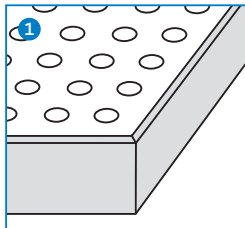

Pre-sanded and primed edges

### 2.3.2 Board cut-outs

- Cut-outs, e.g. for cavity wall sockets or pipe fairleads, should be measured out, drawn onto the board and cut using a cavity wall core drill, keyhole saw or jig saw 2.

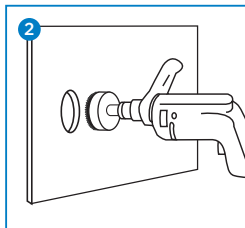

Cutting cavities into boards

### Chapter contents

|     |                                      |    |
|-----|--------------------------------------|----|
| 3.1 | General construction site conditions | 16 |
| 3.2 | Winter construction                  | 17 |

### 3.1 General construction site conditions

The following recommendations and notes are provided to avoid defects, ensure high-quality installation and provide clarity about the optimum general structural conditions when using gypsum fibreboard systems.

- Conventional perforated plasterboards should **not be installed** in buildings with a long-term relative **humidity level of more than 70 %**.
- Plasterboard systems should be **protected from long-term exposure to moisture after installation**.
- **Sufficient ventilation** should also be ensured in buildings **after installation work is complete**.
- **Filing work** may only be carried out once **no more major changes in the length** of the plasterboards are expected as a result of changes in moisture and temperature levels.
- The room temperature may **not fall below approx. + 5 °C for filling work**.
- **Plastering and floor installing** has to be **complete finished**.

### 3.2 Winter construction

- **Rapid, sudden heating** of rooms should be **avoided**, as stress cracks may otherwise occur as a result of changes in length.
- **Direct blowing** of hot or warm air onto the plasterboard surfaces should be **avoided**.
- **Sufficient ventilation** must be ensured.

#### Special notes

- Plastering and screed work generally lead to a drastic increase in relative humidity levels. **Thorough and even ventilation** must be ensured.
- Any mineral wool installed must comply with the Ordinance on Hazardous Substances (GefStoffV) and the DIN EN 13162 standard.
- If hot asphalt is to be used for the screed, filling work may only be carried out after the screed has cooled.

#### Rigips information

These statements about construction site conditions are supported by the plasterboard industrial group (IGG) of the Federal Association of the Gypsum Industry – see IGG guideline no. 1 "Construction site conditions for drylining work using plasterboard systems".

**Chapter contents**

|            |   |           |
|------------|---|-----------|
| <b>4.1</b> | <b>General requirements</b>                                       | <b>20</b> |
| 4.1.1      | Expansion and settlement joints                                   | 21        |
| <b>4.2</b> | <b>Suspended Rigitone perforated ceiling</b>                      | <b>22</b> |
| <b>4.3</b> | <b>Impact-resistant Rigitone sports hall ceilings</b>             | <b>30</b> |
| <b>4.4</b> | <b>Rigitone F 30 ceiling</b>                                      | <b>32</b> |
| 4.4.1      | Installation of lighting and inspection hatches                   | 36        |
| <b>4.5</b> | <b>Cooling and heating systems using Rigitone Climafit boards</b> | <b>41</b> |

## 4.1 General requirements

### Wall plugs or screws

- Wall plugs must have general building code approval for the anchoring of suspended ceilings in accordance with DIN EN 13964 for the substrate concerned.

### Centre-to-centre distances in the substructure

- Rigips nonius hanger systems should always be selected where the suspension elements need to be rigid under compression.
- Rigips nonius hanger systems may be loaded with up to 0.40 kN.
- The nonius adjusting bar and the appropriate lower section for the substructure should generally be secured using two fastening elements.
- Load-bearing hangers must always be perpendicular and arranged in such a way that they connect the substructure to the slab without any play.

### Substructures

- Substructures are made from Rigips CD ceiling profiles in accordance with DIN 18182 and DIN EN 14195. For suspended ceilings, they generally comprise base and supporting batons/profiles.
- In CD profile structures, the profiles are connected using Rigips angle anchors or Rigips crossover fast connectors.
- The centre-to-centre distances in the substructure are oriented to the individual Rigips ceiling systems (see page 22)

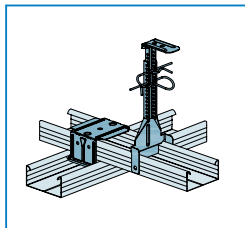

### ! Note

Alternatively, the substructure could be also fixed with the Rigips "Klick Fix" or U-Direct hanging. The fixing to a wide span support (max.l/300) is also possible.

## 4.1.1 Expansion and settlement joints

### ! Notes

- In general, expansion joints in the shell must be observed and continued into the ceiling structure.
- In addition, expansion joints should general be included longitudinally and laterally at intervals of approx. 10 m.
- The stated side lengths should be reduced where free movement of the ceiling area is prevented or where elongated ceilings with relatively large integrated lighting systems (e.g. corridor ceilings) are installed.

Layouts where the free movement of the ceiling area is prevented should be formed as follows:

### Re-entrant structural components

- Open expansion joint
- Sliding expansion joint (settlement joint) necessary

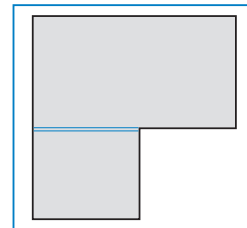

### Re-entrant shear walls

- Open expansion joint
- Sliding expansion joint (settlement joint) necessary

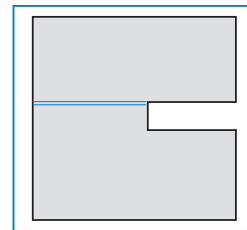

### Suspended ceilings with cavities for supports

- Sliding joint necessary

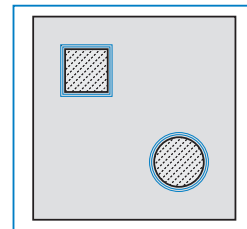

## 4.2 Suspended Rigitone perforated ceiling

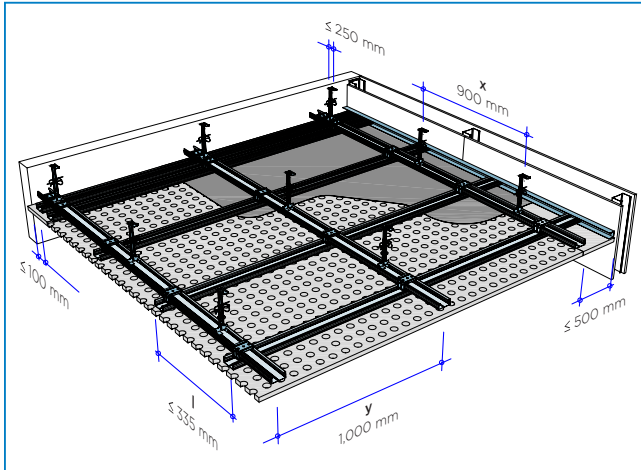

### Substructure

- Base profiles: RigiProfil MultiTec CD 60/27
- Supporting profiles: RigiProfil MultiTec CD 60/27
- Hangers: nonius hangers
- Profile connectors: Rigips crossover fast connectors

Centre-to-centre distances between supporting profiles as per the perforation pattern  $\leq 335$  mm

| Product                            | Centre-to-centre distances between supporting profiles mm |
|------------------------------------|---|
| Rigitone Activ'Air 6/18 R          | 333   |
| Rigitone Activ'Air 8/18 R          | 333   |
| Rigitone Activ'Air 10/23 R         | 333   |
| Rigitone Activ'Air 12/25 R         | 333   |
| Rigitone Activ'Air 15/30 R         | 330   |
| Rigitone Activ'Air 12-20/66 R      | 330   |
| Rigitone Activ'Air 8-15-20 R       | 333   |
| Rigitone Activ'Air 8-15-20 super R | 327   |
| Rigitone Activ'Air 12-20-35 R      | 333   |
| Rigitone Activ'Air 8/18 Q          | 333   |
| Rigitone Activ'Air 12/25 Q         | 333   |

### Substructure spacing

| Base profile<br>RigiProfil MultiTec<br>CD 60/27 | Intervals between hangers<br>Load class kN/m <sup>2</sup> |                       | Supporting profile<br>RigiProfil MultiTec<br>CD 60/27 |
|---|---|-----------------------|---|
|   | up to 0,15<br>x<br>mm                                     | up to 0,30<br>x<br>mm |   |
| y<br>mm   | x<br>mm   | x<br>mm               | l<br>mm   |
| 500   | 1.200   | 950                   | max. 335  |
| 600   | 1.150   | 900                   | max. 335  |
| 700   | 1.100   | 850                   | max. 335  |
| 800   | 1.050   | 750                   | max. 335  |
| 900   | 1.000   | 800 <sup>1)</sup>     | max. 335  |
| 1.000   | 900   | 750 <sup>1)</sup>     | max. 335  |
| 1.100   | 900   | 700 <sup>1)</sup>     | max. 335  |
| 1.200   | 900   | 650 <sup>1)</sup>     | max. 335  |

**Note:** Board weight + substructure + 20 mm mineral wool < 15 kg/m<sup>2</sup> (0.15 kN/m<sup>2</sup>). Additional layers will increase the total surface weight of the ceiling and may result in classification in the load class up to 0.30 kN/m<sup>2</sup>.

<sup>1)</sup> Hanger load capacity class 0.40 kN

### Panelling

- Rigitone Activ'Air 6/18 R, 8/18 R, 10/23 R, 12/25 R, 15/30 R, 12-20/66 R, 8-15-20 R, 8-15-20 super R, 12-20-35 R, 8/18 Q, 12/25 Q
- Rigitone Climafit 6/18 R, 8/18 R, 8-15-20 super R, 8/18 Q, 12/25 Q

### Mineral wool layer

- In the area above the suspended ceiling, depending on requirements

**Board installation**

Begin by installing the first board in the centre of the room ①. The first board should be aligned and fastened into place using an alignment line or preferably a fixed edge guide.

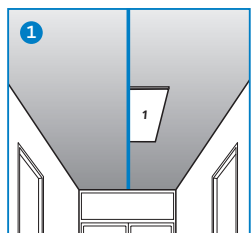

Work outwards from the centre of the room in a star pattern when mounting subsequent boards ②. Making sure that they are all laid in the same direction (see markings on the ends and lettering on the long edges of the boards).

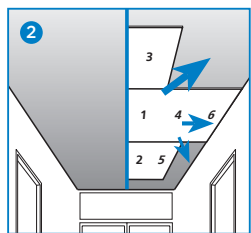
**Installation**

- The substructure – comprising Rigips base and supporting profiles – should be mounted and aligned in such a way that the Rigitone boards can be fastened at right angles to the supporting profiles. A supporting profile must always be located at the transverse joints of the boards.
- The Rigitone boards should be fastened into place using Rigitone 3.5 x 30 mm perforated panel screws at intervals of  $\leq 170$  mm; the Rigitone boards should be fastened along the short side first, then the long side.
- Any minor unevenness in the surface under the boards can be compensated by loosening the screws slightly ③.

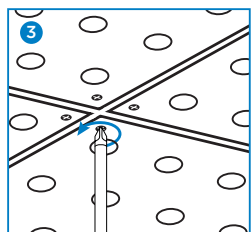
**! Notes**

Two techniques can be used to install Rigitone boards:

- Filling of Rigitone perforated boards using the Joint Filling Technique with the proven Rigitone Fix Joint Filling Set and VARIO joint filler.
- Filling of Rigitone perforated boards using the Joint Filling Technique with the Rigips ReadyMix Set and Rigitone Mix (ready filler). (More details on the filling techniques can be found in the joint filling techniques section).

### Wall joints

To even out structural tolerances, a non-perforated board strip should be installed around the edges.

#### **i** Rigits information

Rigitone boards can also be supplied with non-perforated edges on inquiry.

### Filled joints with RigiProfil MultiTec UD 28 joint profile / border

When joining a Rigitone perforated board ceiling to a building wall which is to be plastered, Rigits TrennFix strips should be inserted before filling to ensure clean separation of the different materials.

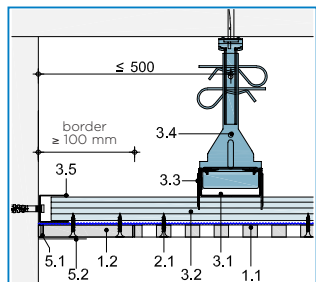

Transverse edge

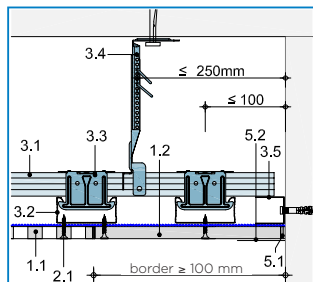

Longitudinal edge

- 1.1 Rigitone perforated board
- 1.2 Border - Rigits standard plasterboard
- 2.1 Rigitone screws
- 3.1 RigiProfil MultiTec CD 60/27 (Base profile)
- 3.2 RigiProfil MultiTec CD 60/27 (Supporting profile)

- 3.3 Rigits crossover fast connector
- 3.4 Rigits 400 N nonius hanger-system
- 3.5 RigiProfil MultiTec UD 28
- 5.1 Rigits jointing
- 5.2 Reinforcement strips or Rigits TrennFix according to the processing guidelines

#### **!** Note

Screw connection to the RigiProfil MultiTec UD 28 is not allowed.

### Joints with shadow gaps

In separated ceiling to wall joints, the intervals between the supporting profiles and the wall should be max. 150 mm. A Rigits AquaBead L-Trim or a Rigits 13/25-045 end profile ("Goeppinger profile") may also be embedded in the filler flush to the surface along the free board edges.

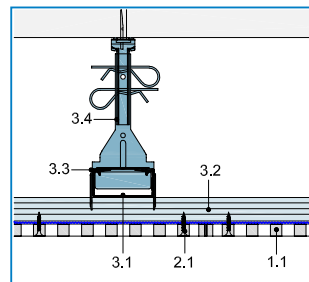
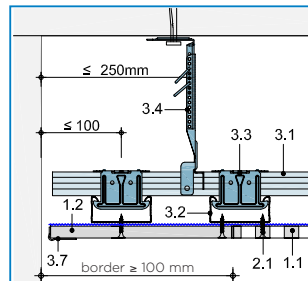

Rigitone short edge joint

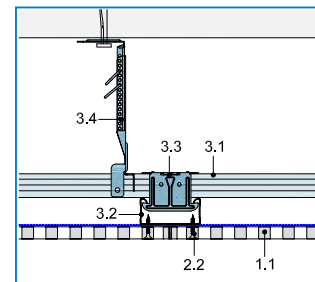

Rigitone long edge joint

- 1.1 Rigitone perforated board
- 1.2 Border - Rigits standard plasterboard
- 2.1 Rigitone screws
- 3.1 RigiProfil MultiTec CD 60/27 (Base profile)
- 3.2 RigiProfil MultiTec CD 60/27 (Supporting profile)

- 3.3 Rigits crossover fast connector
- 3.4 Rigits nonius hanger
- 3.7 Rigits AquaBead L-Trim or Rigits 13/25-045 end profile ("Goeppinger profile")

### Expansion and settlement joints

Basically, the Settlement joints have to be considered and take over from the building. Expansion joints have to be basically placed at intervals of about 10 m in both direction. A reduction of the lengths is required when a free deformation the ceiling surface obstructed or long ceilings with relatively large downlights (eg. as corridor ceilings) to be installed.

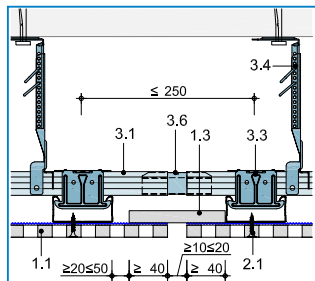

- 1.1 Rigitone perforated board
- 1.3 Rigips standard plasterboard
- 2.1 Rigitone screw
- 3.1 RigiProfil MultiTec CD 60/27
- 3.3 Rigips crossover fast connector
- 3.4 Rigips nonius hanger system
- 3.6 Rigips ceiling profile connector

Cross section: Settlement joint with profile cover for Rigips acoustic ceilings

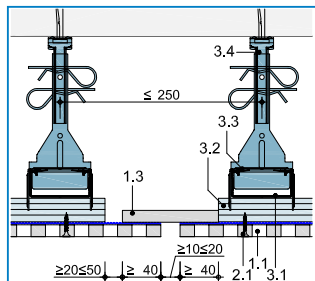

Longitudinal section: Settlement joint with profile cover for Rigips acoustic ceilings

### Material requirements per m<sup>2</sup> – taking Rigips system ADIORTA as an example

|   |                      |
|---|----------------------|
| Rigitone Activ'Air 6/18 R perforated panel – filled joint | 1.0 m <sup>2</sup>   |
| RigiProfil MultiTec CD 60/27                              | 4,400 mm             |
| RigiProfil MultiTec UD 28 joint profile                   | 1,200 mm             |
| Rigips CD 250 nonius lower section                        | 1.20 units           |
| Rigips 140/85 mm nonius upper section                     | 1.20 units           |
| Rigips nonius safety clips                                | 2.40 units           |
| Anchoring element in accordance with DIN 18168            | 1.20 units           |
| Rigips ceiling profile connectors                         | 0.50 units           |
| Rigips crossover fast connectors                          | 3.90 units           |
| 3.5 x 30 mm Rigitone perforated panel screws              | 24 units             |
| Rikombi Grund   | 10 ml/m <sup>2</sup> |
| VARIO joint filler  | 0.25 kg              |



### 4.3 Impact-resistant Rigitone sports hall ceilings

Most of the Rigitone perforated ceilings are classified as "impact-resistant" in accordance with DIN 18032, Part 3.

#### Substructure

The impact resistance is achieved by reducing the centre-to-centre distance between the supporting profiles.

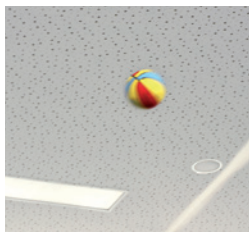

#### Installation systems

Rigitone perforated ceilings are installed with the appropriate intervals between profiles and may be realized using either the Joint Filling Technique. 3.5 x 30 mm Rigitone perforated panel screws should be fastened into place at intervals of 170 mm.

**Table 1: Centre-to-centre distance between supporting profiles as per the perforation pattern**

| Product                            | Intervall between profiles<br>200 mm |
|------------------------------------|--------------------------------------|
| Rigitone Activ'Air 6/18 R          | X                                    |
| Rigitone Activ'Air 8/18 R          | X                                    |
| Rigitone Activ'Air 10/23 R         | X                                    |
| Rigitone Activ'Air 12-20-35 R      | X                                    |
| Rigitone Activ'Air 8-15-20 R       | X                                    |
| Rigitone Activ'Air 8-15-20 super R | X                                    |

#### Material requirements per m<sup>2</sup> – taking Rigipec system AD10RTA as an example

|   |                                  |
|---|----------------------------------|
| Rigitone Activ'Air 6/18 R perforated panel - filled joint | 1.0 m <sup>2</sup>               |
| RigiProfil MultiTec CD 60/27 ceiling profile              | 4,400 mm                         |
| RigiProfil MultiTec UD 28 joint profile                   | 1,200 mm                         |
| Rigips CD 250 nonius lower section                        | 1.20 units                       |
| Rigips 140/85 mm nonius upper section                     | 1.20 units                       |
| Rigips nonius safety clips                                | 2.40 units                       |
| Anchoring element in accordance with DIN 18168            | 1.20 units                       |
| Rigips ceiling profile connectors                         | 0.50 units                       |
| Rigips crossover fast connectors                          | 3.90 units                       |
| 3.5 x 30 mm Rigitone perforated panel screws              | 28 units                         |
| Joint filler demand                                       | Depending on the joint technique |

#### 4.4 Rigitone F 30 ceiling

An F 30 ceiling will exhibit a fire resistance of up to 30 minutes in the event of a fire either from the area above the suspended ceiling or the room. This is a requirement particularly for escape routes, e.g. in public buildings, hospitals, schools and administrative buildings.

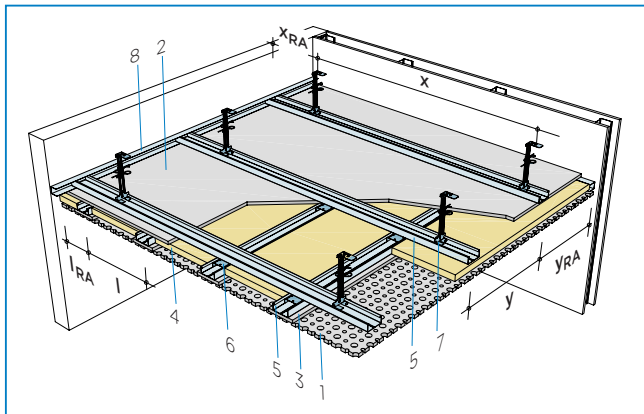

- 1 Rigitone perforated panel
- 2 Rigips RF fireproof board
- 3 Rigips RF fireproof board strip, d = 12.5 mm, b = 100 mm
- 4 Mineral wool, d ≥ 25 mm in accordance with DIN EN 13162 building material classification A, melting point ≥ 1,000 °C (e.g. ISOVER EP3)
- 5 RigiProfil MultiTec CD 60/27
- 6 Rigips "Klick Fix" direct fasteners
- 7 Rigips nonius hanger system,  
Load capacity class 0.25 kN (fire from the room)  
Load capacity class 0.40 kN (fire from the area above the suspended ceiling)
- 8 RigiProfil MultiTec UD 28

#### Substructure

- Base profiles: RigiProfil MultiTec CD 60/27
- Supporting profiles: RigiProfil MultiTec CD 60/27
- Hangers: Nonius hangers  
Load capacity class 0.25 kN (fire from the room) or  
Load capacity class 0.40 kN (fire from the area above the suspended ceiling)
- Rigips "Klick Fix" direct fasteners

#### Panelling

- One layer of Rigitone Activ'Air 6/18 R, 8/18 R, 10/23 R, 12/25 R, 15/30 R, 12-20/66 R, 8-15-20 R, 8-15-20 super R, 12-20-35 R, 8/18 Q, 12/25 Q according to certificate

#### ! Note

It must be noted that, in the event of a fire in the area above the suspended ceiling, the slab must have a fire resistance category of at least F 30.

#### Substructure spacing

|  | Fire in the suspended ceiling |                          |
|--|-------------------------------|--------------------------|
|  | From below                    | From above <sup>1)</sup> |
| Hanger system  | Nonius CD 250                 | Nonius CD 400            |
| <b>l</b> Centre-to-centre distance between supporting profiles | ≤ 320 mm                      | ≤ 320 mm                 |
| <b>x</b> Intervals between hangers                             | ≤ 1,000 mm                    | ≤ 850 mm                 |
| <b>y</b> Centre-to-centre distance between base profiles       | ≤ 500 mm                      | ≤ 500 mm                 |

<sup>1)</sup> from the area above the suspended ceiling

**Wall joints**

Wall joints to F 30 ceilings can be realized either with or without RigiProfil MultiTec UD 28. It is essential that the edge distances are observed:

**Edge spacing in the substructure**

| Edge spacing          |   | With joint profile           | Without joint profile |
|-----------------------|---|------------------------------|-----------------------|
| <b>I<sub>RA</sub></b> | Spacing between supporting profiles (centre) <-> wall | ≤ 130 mm                     | ≤ 130 mm              |
| <b>X<sub>RA</sub></b> | Spacing between hangers                               | ≤ 1,000 mm (fire from below) | ≤ 250 mm              |
|                       |   | ≤ 850 mm (fire from below)   | ≤ 200 mm              |
| <b>Y<sub>RA</sub></b> | Spacing between base profiles (centre) <-> wall       | ≤ 500 mm                     | ≤ 130 mm              |

<sup>1)</sup> from the area above the suspended ceiling

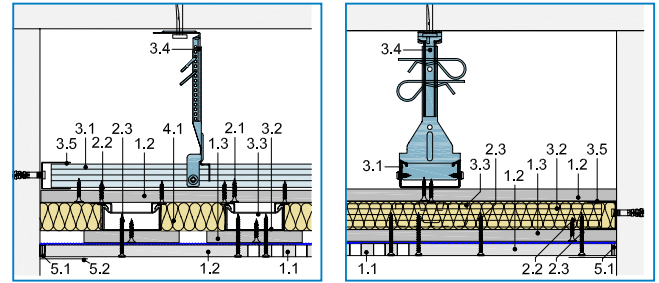

Wall joints with border to building wall using RigiProfil MultiTec UD 28

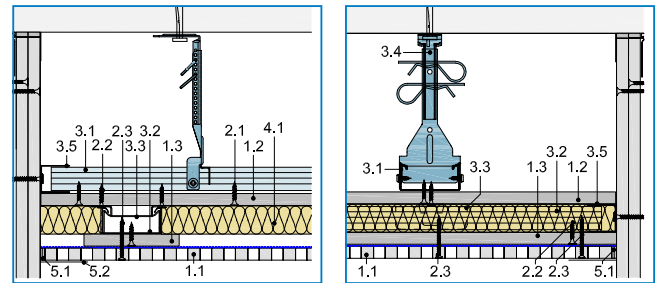

Wall joints without border to Rigips panelled wall > F 30

- 1.1 Rigitone board
- 1.2 Rigips RF fireproof boards
- 1.3 Rigips RF fireproof board strips, d = 12.5 mm, b = 100 mm
- 2.1 Rigips TN 3.5 x 25 mm drywall screws, a = 170 mm
- 2.2 Rigips TN 3.5 x 25 mm drywall screws, a = 750 mm
- 2.3 Rigips TN 3.5 x 35 mm drywall screws, a = 170 mm
- 3.1 Base profiles: RigiProfil MultiTec CD 60/27
- 3.2 Supporting profiles: RigiProfil MultiTec CD 60/27
- 3.3 Rigips "Klick Fix" direct fasteners
- 3.4 Rigips nonius hanger system
  - Load capacity class 0.25 kN (fire from the room)
  - Load capacity class 0.40 kN (fire from the area above the suspended ceiling)
- 3.5 RigiProfil MultiTec UD 28
- 4.1 Mineral wool, d ≥ 25 mm in accordance with DIN EN 13162 building material classification A, melting point ≥ 1,000 °C (e.g. ISOVER EP3)
- 5.1 Rigips Joint filling
- 5.2 Rigips reinforcement strip or Rigips TrennFix according to the processing guidelines

#### 4.4.1 Installation of lighting and inspection hatches

It is possible to install ceiling lighting and inspection hatches, but they can usually only be positioned between the supporting profiles. If installations are particularly heavy, an additional profile in the profile tables must be taken into account (see page 23). Inspection hatches permit quick and practical access to installations in the ceiling cavity at all times. The inspection hatches from RuG Senim GmbH have been tested from both sides (bottom up / top down) for fire safety with the Rigitone F 30 ceiling.

##### Installation of lighting panels

Glasroc F housings are installed in an F 30 ceiling here.

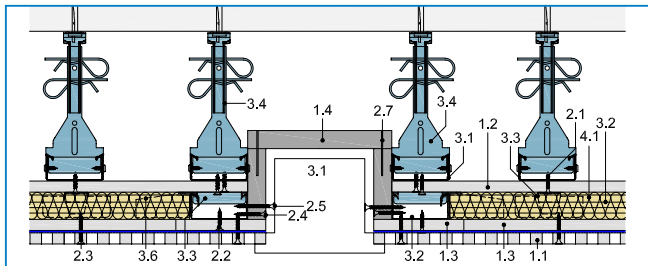

Installation of lighting panels

- 1.1 Rigitone perforated panel
- 1.2 Rigips RF fireproof board
- 1.3 Rigips RF fireproof board strips,  $d = 12.5 \text{ mm}$ ,  $b = 100 \text{ mm}$
- 1.4 Rigips Glasroc F 20 mm
- 2.1 Rigips TN 3.5 x 25 mm drywall screw,  $a = 170 \text{ mm}$
- 2.2 Rigips TN 3.5 x 25 mm drywall screw,  $a = 750 \text{ mm}$
- 2.3 Rigips TN 3.5 x 35 mm drywall screw,  $a = 170 \text{ mm}$
- 2.4 Rigips TN 3.5 x 25 mm drywall screw,  $a = 170 \text{ mm}$
- 2.5 Rigips TB 3.5 x 45 mm drywall screw
- 2.7 Steel wire clips – dimensions: 50/11.25/1.53 mm
- 3.1 base profile: RigiProfil MultiTec CD 60/27
- 3.2 Supporting profile: RigiProfil MultiTec CD 60/27
- 3.3 Rigips "Klick Fix" direct fasteners
- 3.4 Rigips nonius hanger system  
Load capacity class: 0.25 kN (fire from the room)  
Load capacity class: 0.40 kN (fire from the area above the suspended ceiling)
- 3.6 CD safety transverse connector
- 3.7 Angle made from RigiProfil MultiTec CD 60/27 ( $l = 150 \text{ mm}$ )
- 4.1 Mineral wool,  $d \geq 25 \text{ mm}$  in accordance with DIN EN 13162 building material classification A, melting point  $\geq 1,000 \text{ °C}$  (e.g. ISOVER EP5)

#### Installation of inspection hatch closures

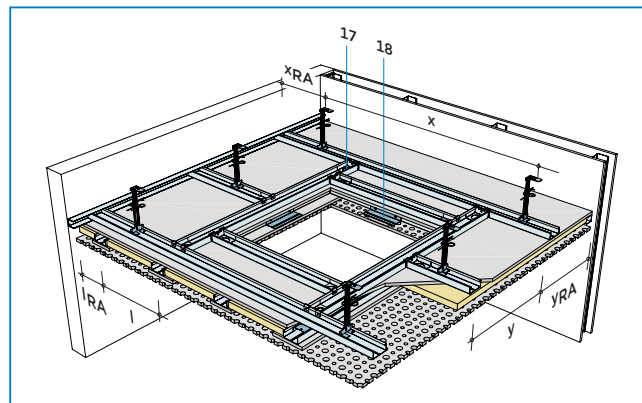

##### Substructure

- Base profiles: RigiProfil MultiTec CD 60/27
- Supporting profiles: RigiProfil MultiTec CD 60/27
- Profile connectors: Rigips safety transverse connector

##### Installation

- The metal substructure should be replaced with CD ceiling profiles on all sides at the same level as the base and supporting profiles.
- The replaced profiles should be fastened together and to the substructure using safety transverse connectors.
- The surrounding fireproof board strips and Rigitone boards should be fastened to the frame using Rigips TN 3.5 x 25 / TN 3.5 x 35 drywall screws at intervals of 170 mm.

The inspection hatches should be fastened to the suspended ceiling using Rigips TN 3.5 x 35 mm drywall screws at intervals of approx. 170 mm. The weight of the inspection hatch is transferred into the substructure via four 150 mm long angles located at the middle point on each side. These angles should be cut from a CD profile and screwed into the frame using two 3.8 x 11 mm construction screws for each.

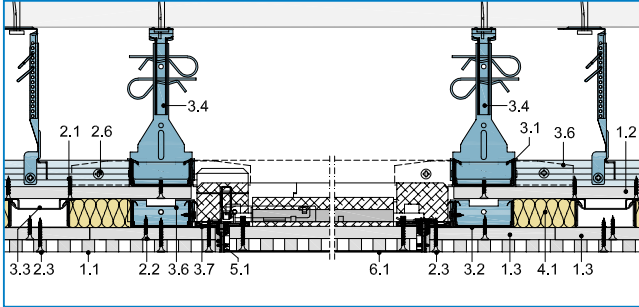

RUG AluProtect® F 30 inspection hatch

To protect the ceiling from fire coming from the area above it (from above) the fire protection set supplied with the inspection hatch must be installed. The Alumatic F 30 fire protection set made of mineral wool is only necessary where a fire from above is a possibility.

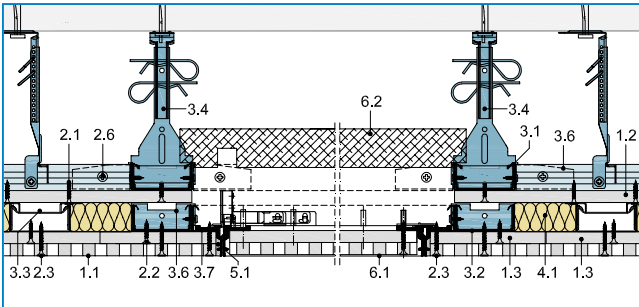

RUG Alumatic F 30 inspection hatch

- 1.1 Rigitone perforated board
- 1.2 Rigips RF fire proof board
- 1.3 Rigips RF fireproof board strips,  $d = 12,5$  mm,  $b = 100$  mm
- 2.1 Rigips TN 3.5 x 25 mm dry wall screw,  $a = 170$  mm
- 2.2 Rigips TN 3.5 x 25 mm dry wall screw,  $a = 170$  mm
- 2.3 Rigips TN 3.5 x 35 mm dry wall screw,  $a = 170$  mm
- 2.7 Steel wire clips – dimensions: 50/11.25/1.53 mm
- 3.1 base profile: RigiProfil MultiTec CD 60/27
- 3.2 Supporting profile: RigiProfil MultiTec CD 60/27
- 3.3 Rigips “Klick Fix” direct fasteners
- 3.4 Rigips nonius hanger system
  - Load capacity class: 0.25 kN (fire from the room)
  - Load capacity class: 0.40 kN (fire from the area above the suspended ceiling)
- 3.6 CD safety transverse connector
- 3.7 Angle made from RigiProfil MultiTec CD 60/27 ( $l = 150$  mm)
- 4.1 Mineral wool,  $d \geq 25$  mm in accordance with DIN EN 13162 building material classification A, melting point  $\geq 1,000$  °C
- 5.1 Rigips joint filling
- 6.1 Inspection hatch RUG Semin GmbH
- 6.2 Fire protection set

## Rigitone F 30 system overview

| Rigips-system-no. | Panelling        |  | Substructure                 |                              | Fastening      | Weight<br>Suspended ceiling approx kg/m <sup>2</sup> | Span  |               | Fire protection           |                           | Fire-resistance-category |
|-------------------|------------------|--|------------------------------|------------------------------|----------------|--|---|---------------|---------------------------|---------------------------|--------------------------|
|                   | RF + Rigitone mm |  | Base profile                 | Supporting profile           |                |  | Distance between profiles Supporting profile y mm | Board Span mm | Mineral wool Thickness mm | Density kg/m <sup>2</sup> |                          |
| AD11RTRF          | 12.5 + 12.5      |  | RigiProfil MultiTec CD 60/27 | RigiProfil MultiTec CD 60/27 | Nonius hangers | 27   | 850   | 500           | 25                        | 90                        | F 30-A                   |
|                   |                  |  |                              |                              |                |  | Fire from the area above the suspended ceiling    |               |                           |                           |                          |
|                   |                  |  |                              |                              |                |  | 1.000   | 500           |                           | 320                       |                          |
|                   |                  |  |                              |                              |                |  | Fire from the room                                |               |                           |                           |                          |

#### 4.5 Cooling and heating systems using Rigitone Climafit boards

Rigitone Climafit boards are graphite-modified perforated plasterboards. The combination of gypsum and graphite makes Rigitone Climafit boards electrically conductive and gives them particularly high thermal conductivity in accordance with DIN EN 520 = 0.52 W/(m·K). This makes them an ideal high-performance panelling solution for modern temperature control systems such as heating or cooling ceilings.

In addition to the processing uidelines stated here, DIN EN 13162, 18181 and the manufacturer's instructions should generally be observed.

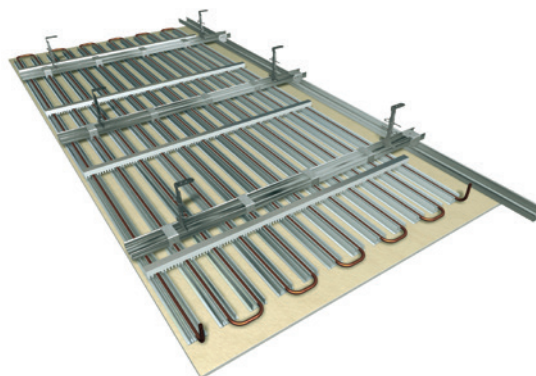

#### Substructure / cooling and heating technology

The substructure always forms part of the air conditioning technology. Panel temperature control system structures vary depending on the manufacturer, meaning that the manufacturer's instructions must always be observed during installation. At different axial distances, is the information of the system provider relevant.

#### Panelling

Rigitone Climafit 6/18 R, 8/18 R, 8-15-20 super R, 8/18 Q, 12/25 Q (more pattern on request).

**Fastening**

Climafit drywall screws 23 (3,5 x 23 mm) at intervals of max. 170 mm.

**Earthing**

The cooling ceiling must be grounded by the system provider according to VDI. It is not necessary to earth the Climafit board.

**! Notes**

- Settlement joints in the building shell must be continued into the substructure.
- If there are no information of the system provider, expansion joints must be included for:
  - Cooling ceilings longer than approx. 10 m along the side or with a surface area > 100 m<sup>2</sup>
  - Heating ceilings longer than approx. 7.50 m along the side or with a surface area > 50 m<sup>2</sup>
  - Extremely narrow ceiling areas (e.g. resulting from projecting wall sections)

**Joints to other components**

With joints to other components made of other materials, e.g. lighting, steel beams, etc. a flexible shadow gap must be created. If the ceiling is to be joined to a building wall which is to be plastered, separator strips such as Rigips TrennFix must be inserted before filling to ensure clean separation of the different materials.

**Joint techniques**

Rigitone Climafit perforated boards can be installed using both the Adhesive Joint Technique and Joint Filling Technique.

**Final coating**

The appearance of the Rigitone Climafit is different from that of Rigitone Activ'Air. The appearance of the Rigitone Climafit is different from that of Rigitone Activ'Air. Rigitone Climafit board has one gray speckled plaster core. The paint should be applied particularly evenly with a short-haired lambskin roller. A kind of "cloud formation" can occur. This depends on the direction of view. Further details please refer to page 67.

**! Note**

Due to the large amount of graphite in Rigitone Climafit perforated boards, some of their properties differ from conventional plasterboards. For example, their electrical conductivity results in high requirements in terms of corrosion protection for fasteners. For this reason, only corresponding Climafit drywall screws 23 (3,5 x 23 mm) may be used to fasten Rigitone Climafit perforated boards. The special coating of these screws ensures corrosion protection. In individual cases, this protection may be damaged e.g. by tools, meaning that minor corrosion marks may become visible on the surface after the screw heads have been filled. This is merely surface corrosion which has no impact on the load bearing capacity of the fasteners. In such cases, the affected screws can easily be replaced. Alternatively, a suitable primer may be used on the area around the screw heads before application of further (colour) coatings.

**Chapter contents**

|            |   |           |
|------------|---|-----------|
| <b>5.1</b> | <b>Joint techniques for Rigitone ceilings</b>   | <b>46</b> |
| 5.1.1      | Joint Filling Technique using the Rigitone Fix Joint Filling Set and VARIO joint filler | 46        |
| 5.1.2      | Joint Filling Technique using the Rigips ReadyMix Set and Rigitone Mix ready filler     | 50        |



### 5.1 Joint techniques for Rigitone ceilings

Two techniques can be used when installing Rigitone perforated boards, all of which offer a flawless appearance and long-lasting results with high joint strength and freedom from cracking:

- Rigitone Fix Joint Filling Technique using VARIO joint filler.
- Rigitone Joint Filling Technique using the new Rigips ReadyMix Set and Rigitone Mix (ready filler).

The method of realization depends on the preferred joint technique and the tools and materials available.

#### 5.1.1 Joint Filling Technique using the Rigitone Fix Joint Filling Set and VARIO joint filler



#### Optimum edges

Rigitone boards are ready to install because of its pre-sanded and primed edges at factory site **1**. Cut edges must be pre-sanded and primed. The priming can be applied with Rikombi Grund in a mixing ratio of 1:2.

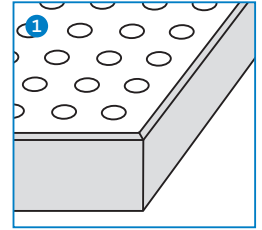

On installing the boards, use the appropriate aids to ensure they are properly aligned and check the alignment before screwing them into place along the perforation rows (straight and diagonal) **2**.

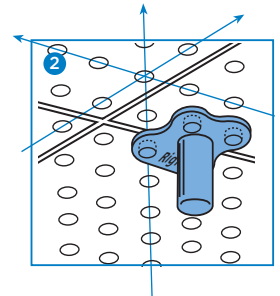

#### Preparing the filler

Sprinkle VARIO joint filler into the appropriate amount of water by hand or direct from the bag **3**. Allow the material to sink in **4** (observe times for this) and then stir. We recommend increasing the water share slightly (approx. 2.8 l of water for 5 kg of VARIO joint filler). The smoother consistency this produces makes working with the Rigitone Fix pistol easier.



#### Processing tip

We recommend wetting the tools before beginning work.

### Using the Rigitone Fix Joint Filling Set



Insert the Rigitone Fix plunger head into the Rigitone Fix cartridge tube and press in firmly.



Hold the cartridge at a slight angle and quickly fill it with the prepared (slightly thinner) VARIO joint filler.



Place the Rigitone Fix cap on the cartridge tube to seal it.



Screw the Rigitone Fix joint nozzle onto the Rigitone Fix cap. Then insert the cartridge tube into the Rigitone Fix pistol.



Hold the Rigitone Fix pistol in a slightly elevated position and press the trigger until there is no more air in the cartridge and the VARIO joint filler runs out of the nozzle in a constant flow.

### Joint filling

Fill the joints generously and completely so that the filler just starts to exude from the reverse of the board

1.

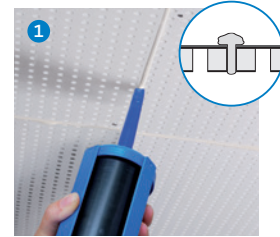

Slightly overfill the screw heads using the Rigips screw head template

2.

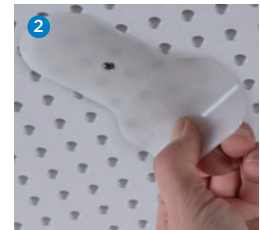

After approx. 30 minutes, carefully remove the slightly hardened excess joint filler using the Rigips scraper

3.

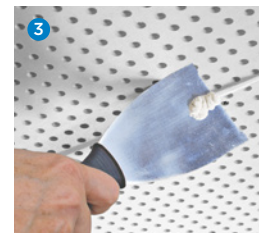

After approx. 3 hours, the joints and covered screw heads can be sanded and prepared for further finishing work

4.



### 5.1.2 Joint Filling Technique using the Rigips ReadyMix Set and Rigitone Mix ready filler



### Using the Rigips ReadyMix Set



1 Insert the bag containing the Rigitone Mix into the pistol and cut off the seal.



2 Screw the Rigitone Fix joint nozzle onto the adapter.



3 Screw the Rigitone Fix joint nozzle and attached adapter tightly onto the Rigips ReadyMix pistol.

**Optimum edges**

Rigitone boards are ready to install because of its pre-sanded and primed edges at factory site **1**. Cut edges must be pre-sanded and primed. The priming can be applied with Rikombi Grund in a mixing ratio of 1:2.

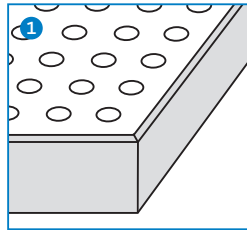

Use the appropriate aids to ensure the boards are properly aligned and check the alignment before screwing them into place along the perforation rows (straight and diagonal) **2**.

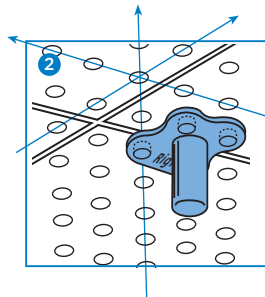

Fill the joints generously and completely so that the filler just starts to exude from the reverse of the board **1**.

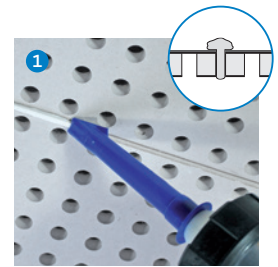

Slightly overfill the screw heads using the Rigsips screw head template **2**.



Once the Rigitone Mix has begun to harden, remove any excess carefully using the Rigsips scraper **3** and then pass the scraper back over the joints in the other direction to smooth the surface.

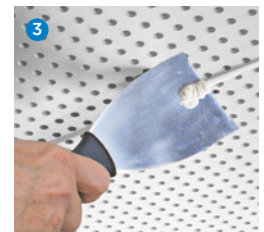

The joints and covered screw heads can be sanded after approx. 24 hours **4**. Further finishing work may be continued once fully dried.



## Chapter contents

|     |  |    |
|-----|--|----|
| 6.1 | Wall facings   | 56 |
| 6.2 | Freestanding wall facing in front of a building wall | 59 |
| 6.3 | Rigitone wall  | 62 |

## 6.1 Wall facings

### Substructure

- RigiProfil MultiTec UD 28 or
- RigiProfil MultiTec CD 60/27 plus Rigips 30/45/60 adjustable stirrups or 90 mm long shanks

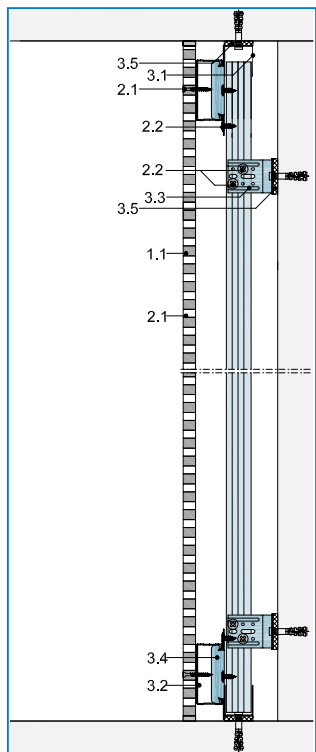

**Variant 1**  
Wall facing with substructure

- 1.1 Rigitone perforated board
- 1.2 Rigips RB construction board
- 2.1 Rigitone screws
- 2.2 Rigips construction screw  
3.8 x 11 mm

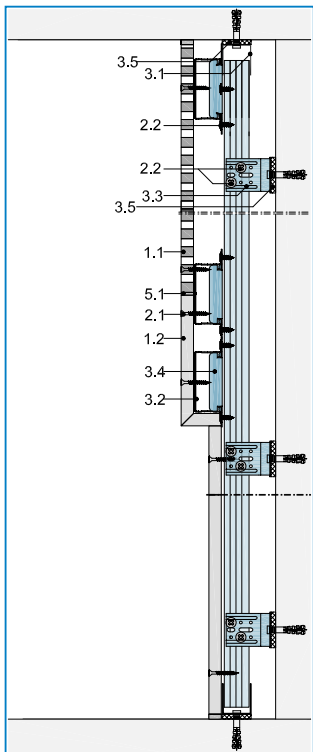

**Variant 2**  
Wall facing with substructure  
and absorber element in the  
upper wall section

- 3.1 RigiProfil MultiTec UD 28
- 3.2 RigiProfil MultiTec CD 60/27
- 3.3 Rigips adjustable stirrup
- 3.4 Rigips "Klick Fix" direct fastener
- 3.5 Rigips felt joint seal
- 5.1 Rigips joint filling

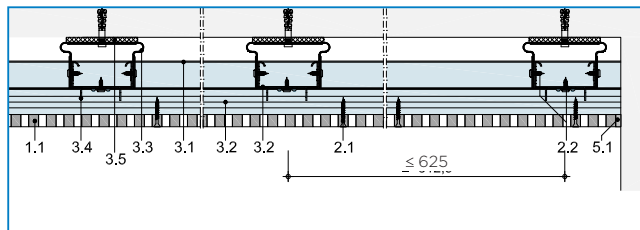

### Substructure installation process

- Bond Rigips felt joint seal to the reverse of the Rigips adjustable stirrup and attach the stirrup to the wall using dowels.
- Vertical interval between adjustable stirrups:  $\leq 335$  mm.
- Stud framework intervals:  $\leq 625$  mm.
- Bond Rigips felt joint seal to RigiProfil MultiTec UD 28 before fastening them to the floor/ceiling using impact or nail dowels at intervals of  $\leq 1,000$  mm.
- Position Rigips C ceiling profiles and fasten them to the Rigips adjustable stirrups using Rigips 3.8 x 11 mm construction screws.
- Insert mineral wool insulation (addition of insulation is generally recommended).
- The intervals between the crossbars in the crossbar structures should be  $\leq 335$  mm for Rigitone boards.
- Fasten the "Klick Fix" direct fasteners for the C ceiling profile into place.
- Click the C ceiling profile into place.

### Variant 2 with substructure and absorber element in the upper wall section

- An additional bar should be installed at the point between the Rigips folding element and Rigitone absorber to enable both to be fastened to the crossbar of the CD ceiling profile.
- The Rigips construction board in the lower section of the wall should be fastened directly to the CD ceiling profile (stud framework) using Rigips TN 3.5 x 25 mm drywall screws at intervals of  $\leq 250$  mm.
- Fasten the Rigitone board into place using Rigitone 3.5 x 30 mm drywall screws at intervals of  $\leq 170$  mm.

### Panelling

- Rigitone Activ'Air 6/18 R, 8/18 R, 10/23 R, 12/25 R, 15/30 R, 12-20/66 R, 8-15-20 R, 8-15-20 super R, 12-20-35 R, 8/18 Q, 12/25 Q
- Rigips construction board



### Rigips recommendation

We recommend installing the Rigitone boards above a height of 1.60 m and using sealed plasterboards below to minimize susceptibility to damage. Rigitone boards do not have the same level of impact resistance and must be completely replaced if they become damaged.

### Installation process

- The Rigitone wall may be realised using the Joint Filling Technique or the Adhesive Joint Technique (see section 5 - joint techniques).
- The correct perforation interval can be achieved by ensuring the correct gaps in the joints:
  - Joint Filling Technique = 3.6 mm
  - Use of the installation aid for irregular scattered perforation is recommended here.



### Notes

- Every Rigips board transverse joint should be fastened to a transom profile.
- Any minor unevenness in the surface under the boards can be compensated by loosening the screws slightly.

## 6.2 Freestanding wall facing in front of a building wall

### Substructure

- RigiProfil MultiTec UW/CW 50-06 wall profile
- RigiProfil MultiTec CD 60/27 with Rigips direct fasteners

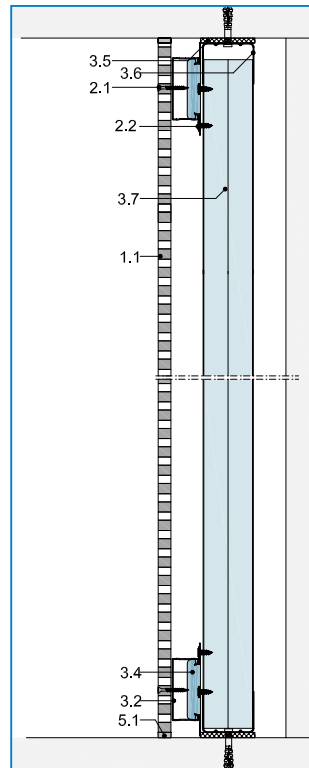

**Variant 1**  
Freestanding wall facing

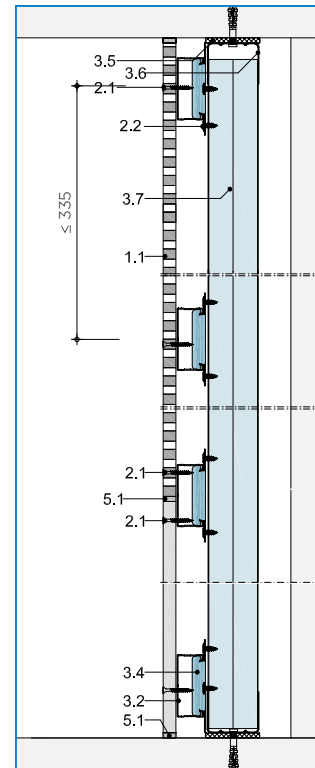

**Variant 2**  
Freestanding wall facing flush with the wall surface using Rigitone boards and Rigips construction boards

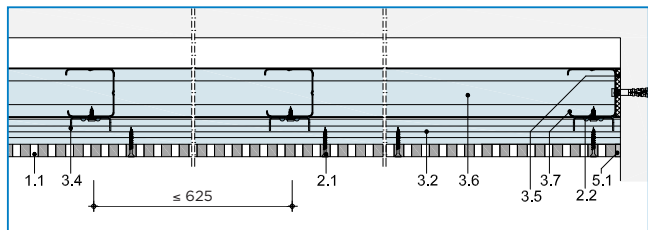

- |  |  |
|--|--|
| 1.1 Rigitone perforated board                | 3.2 RigiProfil MultiTec CD 60/27       |
| 1.2 Rigips RB construction board             | 3.4 Rigips "Klick Fix" direct fastener |
| 2.1 Rigitone screw                           | 3.5 Rigips felt joint seal             |
| 2.2 Rigips construction screw<br>3.8 x 11 mm | 3.6 RigiProfil MultiTec UW             |
|  | 3.7 RigiProfil MultiTec CW             |
|  | 5.1 Rigips joint filling               |

### Substructure installation process

- Bond Rigips felt joint seal to the RigiProfil MultiTec UW/CW 50-06 wall profile and fasten the profile to the floor/ceiling using impact or nail dowels at intervals of  $\leq 1,000$  mm.
- Insert and align RigiProfil MultiTec CW.
- Stud framework intervals:  $\leq 625$  mm.
- Intervals in the crossbar structure:  
 $\leq 500$  mm in the area covered by Rigips construction boards  
 $\leq 335$  mm in the area covered by the Rigitone boards
- Insert mineral wool insulation (addition of insulation is generally recommended).
- Fasten the "Klick Fix" direct fasteners for the C ceiling profile into place on the stud framework profile.
- Click the C ceiling profile into place.

### Variant 2: Freestanding wall facing flush with the wall surface using Rigitone boards and Rigips construction boards

- An additional bar should be installed at the point between the Rigips construction board and the Rigitone boards to enable both to be fastened to the crossbar of the CD ceiling profile.

### Panelling

- Rigips 12.5 mm construction board
- Rigitone Activ'Air 6/18 R, 8/18 R, 10/23 R, 12/25 R, 15/30 R, 12-20/66 R, 8-15-20 R, 8-15-20 super R, 12-20-35 R, 8/18 Q, 12/25 Q

### Rigitone recommendation

We recommend installing the Rigitone boards in the upper third of the wall and using sealed plasterboards below to minimize susceptibility to damage. Rigitone boards do not have the same level of impact resistance and must be completely replaced if they become damaged.

### Installation process

- The Rigips construction board in the lower section of the wall should be fastened directly to the CD ceiling profile (stud framework) using Rigips TN 3.5 x 25 mm drywall screws at intervals of  $\leq 250$  mm.
- Fasten the Rigitone board into place using Rigitone 3.5 x 30 mm perforated panel screws at intervals of  $\leq 170$  mm.
- The Rigitone wall may be realised using the Joint Filling Technique or the Adhesive Joint Technique (see section 5 - joint techniques).



- The correct perforation interval can be achieved by ensuring the correct gaps in the joints:
  - Joint Filling Technique = 3.6 mm.
  - Use of the installation aid for irregular scattered perforation is recommended here.





### 6.3 Rigitone wall

#### Substructure

- RigiProfil MultiTec UW/CW 50-06
- RigiProfil MultiTec CD 60/27 with Rigips direct fasteners.

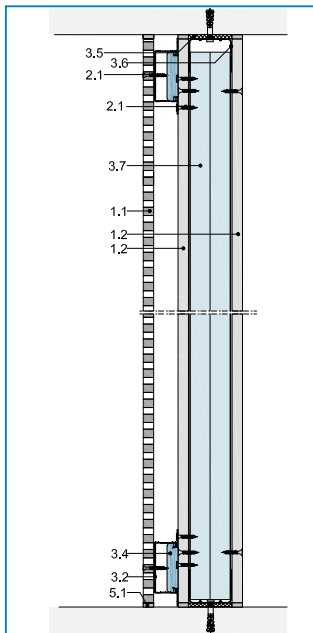

#### Variant 1

Rigips double-sided panelled wall with additional Rigitone panelling on one side

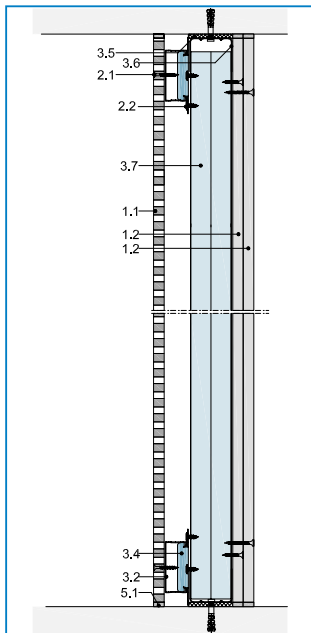

#### Variant 2

Rigips asymmetrically panelled wall (Rigips construction board on one side and Rigitone on CD ceiling profiles on the other side)

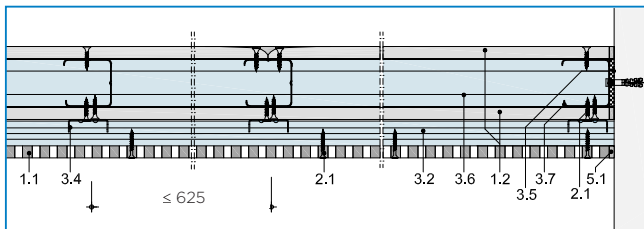

1.1 Rigitone perforated panel

1.2 Rigips RB construction board

2.1 Rigitone screw

2.2 Rigips construction screw  
3.8 x 11 mm

3.2 RigiProfil MultiTec CD 60/27

3.4 Rigips "Klick Fix" direct fastener

3.5 Rigips felt joint seal

3.6 RigiProfil MultiTec UW

3.7 RigiProfil MultiTec CW

5.1 Rigips joint filling

#### Substructure installation process

- Bond Rigips felt joint seal to the RigiProfil MultiTec UW/CW 50-06 wall profile and fasten the profile to the floor/ceiling using impact or nail dowels at intervals of  $\leq 1,000$  mm.
- Insert and align RigiProfil MultiTec CW.
- Stud framework intervals:  $\leq 625$  mm.
- Insert mineral wool insulation (addition of insulation is generally recommended).
- Fasten the "Klick Fix" direct fasteners for the C ceiling profile into the crossbar structure on the panelled wall.
- Click the C ceiling profile into place.
- Intervals in the crossbar structure:  $\leq 335$  mm.

#### Panelling

- Rigips 12.5 mm construction board
- Rigitone Activ'Air 6/18 R, 8/18 R, 10/23 R, 12/25 R, 15/30 R, 12-20/66 R, 8-15-20 R, 8-15-20 super R, 12-20-35 R, 8/18 Q, 12/25 Q

#### Panelling installation process

- Fasten the Rigitone board into place using Rigitone 3.5 x 30 mm perforated panel screws at intervals of  $\leq 170$  mm.
- Fasten the first Rigips construction board layer into place using Rigips TN 3.5 x 25 mm drywall screws and the second layer using Rigips TN 3.5 x 35 mm drywall screws.
- The Rigitone wall may be realised using the Joint Filling Techniques (see section 5 - joint techniques).

**Chapter contents**

|            |   |           |
|------------|---|-----------|
| <b>7.1</b> | <b>Loads on ceilings (with perforation)</b>   | <b>66</b> |
| 7.1.1      | Installations in Rigitone perforated ceilings | 66        |
| <b>7.2</b> | <b>Cavity dowels for ceiling structures</b>   | <b>67</b> |
| <b>7.3</b> | <b>Final coating of Rigitone boards</b>       | <b>67</b> |

## 7.1 Loads on ceilings (with perforation)

### 7.1.1 Installations in Rigitone perforated ceilings

- For installations such as lighting elements or ventilation outlets with dimensions larger than the gaps between profiles, the openings in the ceiling surface must be supported by additional frames in the substructure.
- This generally also applies for installations  $\geq 3 \text{ kg/m}^2$ .
- The weight of the installations must be transferred to the slab by at least two additional Rigips hangers per frame. The number and type of Rigips hangers is also dependent on their load class and the additional load from the installation they need to bear.
- Heavy loads which exceed the permitted loads for dowels and ceiling structures must be attached directly to the slab or a supporting structure which ensures the load is transferred to the slab.

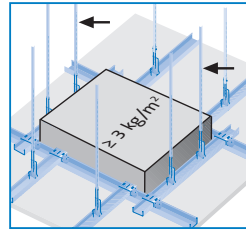

Frame for additional installations

## 7.2 Cavity dowels for ceiling structures

The range of standard cavity dowels shown here may be supplemented by comparable manufacturer-specific dowels.

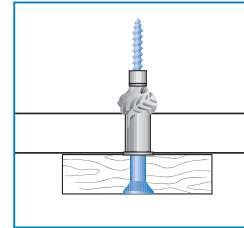

Expandet anchor

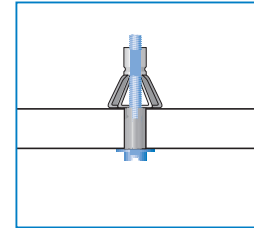

Molly screw anchor  
(comparable with Hilti HHD)

## 7.3 Final coating of Rigitone boards

- A suitable primer is in accordance with Manufacturer specifications of the final coating.
- Paint should be applied using a short-haired lambskin roller. Take care to ensure that the perforations do not become filled with paint. The paint may not be applied using a spraying machine.
- All standard paints, e.g. distemper, emulsion paints and varnishes, oilbased, alkyd resin, polymer resin, polyurethane and epoxy resin paints, are suitable.
- Silicone paint may only be applied with a suitable primer.
- Mineral-based paints such as white-wash and silicate paints (also known as pure silicate paints) are not suitable.
- Dispersion-modified silicate paints (organo-silicate and dispersion-modified silicate paints) may only be used if the manufacturer expressly guarantees their suitability and provides precise processing instructions. Where these paints have to meet specific requirements in terms of performance characteristics (e.g. washability in accordance with DIN EN ISO 11998), these requirements must be expressly guaranteed.

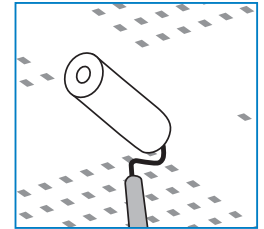

© Saint-Gobain Rigips GmbH

### **1st edition, May 2021**

The information given in this document corresponds to the following: State of our knowledge and experience at Printing (cf. Printing endorsement). Unless expressly agreed otherwise, however, they do not constitute a guarantee in the legal sense. The state of knowledge and experience is constantly evolving.

Therefore, please make sure to use the latest edition of this publication (**[www.rigitone.com](http://www.rigitone.com)**).

The described product applications cannot take into account special circumstances of the individual case. Therefore, check our products for their suitability for the specific purpose of application. If you have any questions, please contact your partners in place of production.

#### **Headquarters**

##### **Saint-Gobain Rigips GmbH**

Schanzenstraße 84  
40549 Duesseldorf  
Germany

Climafit®, Die Dicke von Rigips®, Rifino®, Rifix®, Rigidur®, RigiProfil®, Rigips®, RigipsProfi®, RigiRaum®, RigiSystem®, RigiTherm®, Rigitone®, Rikombi®, Rimat®, RiStuck® and VARIO® are registered brands of Saint-Gobain Rigips GmbH. Activ'Air®, AquaBead®, Aquaroc®, Glasroc®, Gyptone®, Habito® and Levelline® are registered brands of Compagnie de Saint-Gobain.

[rigitone.com](http://rigitone.com)



**Headquarters**  
**Saint-Gobain Rigips GmbH**  
Schanzenstraße 84  
40549 Duesseldorf  
Germany  
Phone +49(0)211 5503-0  
Fax +49(0)211 5503-208  
[info@rigips.de](mailto:info@rigips.de)  
[www.rigips.de](http://www.rigips.de)