

Installation guidelines
Wall, Ceiling, Roof
using Rigidur® gypsum fibreboards



Table of Contents

1.	General	5-17
1.1	Overview of the Rigidur gypsum fibreboards for wall, ceiling and roof structures	6
1.2	Building material classifications / reaction to fire	10
1.3	Rigidur gypsum fibreboard edge shapes	11
1.4	Overview of Rigips plasterboards (extract from range)	12
1.5	Rigips construction and fireproof board edge shapes	12
1.6	Accessory range for wall, ceiling and roof structures	14
2.	Board storage, transportation and processing	19-23
2.1	Storage and transportation	20
2.2	Board processing	22
3.	Site conditions	25-27
3.1	Construction site conditions	26
3.2	Construction in winter	27
4.	Joining techniques	29-41
4.1	Butt joint installation	31
4.2	Filler preparation	32
4.3	Filled joint without reinforcement strips	34
4.4	Filled joint with grid reinforcement strips	35
4.5	Filled joint with glass-fibre or paper reinforcement strips	36
4.6	Adhesive Joint Technique	38
4.7	Practical tips for special situations	40
5.	Fasteners and spacing	43-49
5.1	Rigidur Fix drywall screws / staples	44
5.2	Fastener penetration depth	46
6.	Drylining	51-55
6.1	Substrate requirements	52
6.2	Concealed installations	53
6.3	Mounting of electrical sockets	53
6.4	Installation	54

7.	Wall facings	57 - 63
7.1	Wall facings with substructures fastened to solid walls	58
7.2	Free-standing wall facings	61
7.3	Wall facings anchored to solid walls using wooden laths	63
8.	Shaft walls	65 - 69
8.1	Rigidur shaft walls	66
8.2	Hybrid shaft walls	68
9.	Non-load-bearing partitions	71 - 107
9.1	Wall systems: Metal single stud partition walls	72
9.1.1	Installation order of Metal single stud partition walls	74
9.2	Extending Rigips CW wall profiles	77
9.3	Panelling	78
9.4	Floor and ceiling joints	79
9.5	Mounting of pipe and cable fairleads, electrical sockets, etc.	81
9.6	Double-layer panelling	86
9.7	Anti-burglary protection in drywall construction applications	87
9.7.1	Rigips anti-burglary single stud partition walls - RC 2/RC 3	87
9.8	Rigips hybrid walls	90
9.8.1	Rigips GF Top hybrid wall	90
9.8.2	Rigips GK Top hybrid wall	93
9.9	Wall systems: Metal double stud partition walls	96
9.10	Wall systems: Metal double stud partition walls as installation walls	98
9.11	Installation of sanitary equipment	100
9.12	Wall systems: Wooden single stud partition walls	102
9.13	Wooden substructure/installation process	104
9.14	Wall systems: Wooden double stud partition walls	106

10.	Door openings	109 - 116
10.1	Installation of door openings	110
10.2	Installation of door frames	116
11.	Attic conversion	119 - 125
11.1	Attic panelling	120
11.2	Insulation/vapour barrier	122
11.3	Fixed joints/details	122
11.4	Jamb walls	124
12.	Ceiling systems	127 - 139
12.1	Fitted ceilings	128
12.2	Ceiling panelling	128
12.3	Hanger systems	129
12.4	Joints	134
12.5	Installing Rigidur ceilings	135
12.6	Suspended fitted ceilings	137
12.7	Directly fastened fitted ceilings	138
13.	Finishes	141 - 145
13.1	Substrates	142
13.2	Priming	142
13.3	Painting	143
13.4	Wallpaper	144
13.5	Tiles	144
13.6	Plaster	145
14.	Fastening of loads	147 - 151
14.1	Loads on walls	148
14.2	Loads on ceilings	151

Chapter contents

1.1	Overview of the Rigidur gypsum fibreboards for wall, ceiling and roof structures	6
1.2	Building material classifications / reaction to fire	10
1.3	Rigidur gypsum fibreboard edge shapes	11
1.4	Overview of Rigips plasterboards (extract from range)	12
1.5	Rigips construction and fireproof board edge shapes	12
1.6	Accessory range for wall, ceiling and roof structures	14

1.1 Overview of Rigidur® gypsum fibreboards for wall, ceiling and roof structures









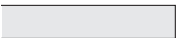

	Board thickness	Format (width x length)	Properties	Applications
Small-format Rigidur® H 10  Four-sided square edge 4SK	10 mm	1,000 x 1,500 mm	Homogeneous gypsum fibreborad - GF-C1-I-W2 in accordance with EN 15283-2 - with square edges (SK). Pre-primed, smooth and extremely hard surface.	For robust wall and ceiling systems with fire protection and sound insulation requirements and for domestic rooms with high moisture levels.
Rigidur® H 10 for installation using the Joint Filling Technique  Four-sided square edge 4SK	10 mm	1,195 x 2,500 mm 1,195 x 3,000 mm 1,245 x 2,000 mm 1,245 x 2,500 mm 1,245 x 3,000 mm	Homogeneous gypsum fibreborad - GF-C1-I-W2 in accordance with EN 15283-2 - with square edges (SK). Pre-primed, smooth and extremely hard surface.	For robust wall and ceiling systems with fire protection and sound insulation requirements and for domestic rooms with high moisture levels.
Rigidur® H 10 for installation using the Adhesive Joint Technique  Four-sided square edge 4SK	10 mm	1,249 x 2,000 mm 1,249 x 2,500 mm 1,249 x 3,000 mm	Homogeneous gypsum fibreborad - GF-C1-I-W2 in accordance with EN 15283-2 - with square edges (SK). Pre-primed, smooth and extremely hard surface.	For robust wall and ceiling systems with fire protection and sound insulation requirements and for domestic rooms with high moisture levels.
Small-format Rigidur® H 12.5  Four-sided square edge 4SK	12.5 mm	1,000 x 1,500 mm	Homogeneous gypsum fibreborad - GF-C1-I-W2 in accordance with EN 15283-2 - with square edges (SK). Pre-primed, smooth and extremely hard surface.	For robust wall and ceiling systems with fire protection and sound insulation requirements and for domestic rooms with high moisture levels.
Rigidur® H 12.5 for installation using the Joint Filling Technique  Four-sided square edge 4SK	12.5 mm	1,195 x 2,750 mm 1,195 x 3,000 mm 1,200 x 2,400 mm 1,200 x 2,500 mm 1,200 x 2,620 mm 1,245 x 2,000 mm 1,245 x 2,500 mm 1,245 x 2,750 mm 1,245 x 3,000 mm	Homogeneous gypsum fibreborad - GF-C1-I-W2 in accordance with EN 15283-2 - with square edges (SK). Pre-primed, smooth and extremely hard surface.	For robust wall and ceiling systems with fire protection and sound insulation requirements and for the panelling of supporting walls in wooden frame and prefabricated house construction.
Rigidur® H 12.5 for installation using the Adhesive Joint Technique  Four-sided square edge 4SK	12.5 mm	1,249 x 2,000 mm 1,249 x 2,500 mm 1,249 x 2,540 mm 1,249 x 2,610 mm 1,249 x 2,630 mm 1,249 x 2,750 mm 1,249 x 3,000 mm	Homogeneous gypsum fibreborad - GF-C1-I-W2 in accordance with EN 15283-2 - with square edges (SK). Pre-primed, smooth and extremely hard surface.	For robust wall and ceiling systems with fire protection and sound insulation requirements and for the panelling of supporting walls in wooden frame and prefabricated house construction.
Small-format Rigidur® H 15  Four-sided square edge 4SK	15 mm	1,000 x 1,500 mm	Homogeneous gypsum fibreborad - GF-C1-I-W2 in accordance with EN 15283-2 - with square edges (SK). Pre-primed, smooth and extremely hard surface.	For robust wall and ceiling systems with fire protection and sound insulation requirements and for domestic rooms with high moisture levels.

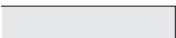
Table continues on the following pages

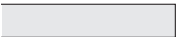
	Board thickness	Format (width x length)	Properties	Applications
Rigidur® H 15 for installation using the Adhesive Joint Technique  Four-sided square edge 4SK	15 mm	1,200 x 2,500 mm 1,249 x 2,000 mm 1,249 x 2,500 mm 1,249 x 2,540 mm 1,249 x 2,750 mm 1,249 x 3,000 mm	Homogeneous gypsum fibreboard – GF-C1-I-W2 in accordance with EN 15283-2 – with square edges (SK). Pre-primed, smooth and extremely hard surface.	For robust wall and ceiling systems with fire protection and sound insulation requirements and for the panelling of supporting walls in wooden frame and prefabricated house construction.
Rigidur® H 18 for installation using the Adhesive Joint Technique  Four-sided square edge 4SK	18 mm	1,200 x 2,400 mm 1,250 x 3,040 mm	Homogeneous gypsum fibreboard – GF-C1-I-W2 in accordance with EN 15283-2 – with square edges (SK). Pre-primed, smooth and extremely hard surface.	For extremely robust wall systems. Ideal for attaching loads.
Rigidur® H AK 12.5  Tapered longitudinal edges AK	12.5 mm	1,200 x 2,400 mm 1,200 x 2,700 mm 1,200 x 2,800 mm 1,200 x 3,000 mm 1,249 x 2,000 mm 1,249 x 2,500 mm 1,249 x 3,000 mm 1,249 x 2,750 mm	Homogeneous gypsum fibreboard – GF-C1-I-W2 in accordance with EN 15283-2 – with square edges (SK). Pre-primed, smooth and extremely hard surface.	For robust wall and ceiling systems with fire protection and sound insulation requirements and for the panelling of supporting walls in wooden frame and prefabricated house construction.
Rigidur® H AK 15  Tapered longitudinal edges AK	15 mm	1,200 x 2,400 mm 1,200 x 2,800 mm 1,200 x 3,000 mm 1,249 x 2,000 mm 1,249 x 2,500 mm 1,249 x 2,540 mm 1,249 x 2,750 mm 1,249 x 3,000 mm	Homogeneous gypsum fibreboard – GF-C1-I-W2 in accordance with EN 15283-2 – with tapered longitudinal edges (AK). Pre-primed, smooth and extremely hard surface.	For robust wall and ceiling systems with fire protection and sound insulation requirements and for the panelling of supporting walls in wooden frame and prefabricated house construction.
Rigidur® H A1 10  Four-sided square edge 4SK	10 mm	1,249 x 2,000 mm	Homogeneous gypsum fibreboard – GF-C1-I-W2 in accordance with EN 15283-2 – with square edges (SK). Pre-primed, smooth and extremely hard surface.	For maximum preventive fire safety.
Rigidur® H A1 12,5  Four-sided square edge 4SK	12.5 mm	1,249 x 2,000 mm 1,249 x 2,750 mm	Homogeneous gypsum fibreboard – GF-C1-I-W2 in accordance with EN 15283-2 – with square edges (SK). Pre-primed, smooth and extremely hard surface.	For maximum preventive fire safety.
Rigidur® Hs_d  Four-sided square edge 4SK	12.5 mm	1,249 x 2,750 mm 1,249 x 3,000 mm	Homogeneous gypsum fibreboard – GF-C1-I-W2 in accordance with EN 15283-2 – with square edges (SK). Pre-primed, smooth and extremely hard surface, with vapour barrier properties.	Suitable for the creation of vapour-permeable exterior wall structures made of Rigidur H gypsum fibreboards without an additional film as structural panelling with fire protection and sound insulation requirements.

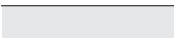
1.2 Building material classifications/ reaction to fire

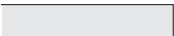
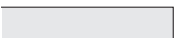
Rigidur® H

Gypsum fibreboard GF-C1-I-W2 in accordance with EN 15283-2

Rigidur H gypsum fibreboards are standardized construction products in accordance with EN 15283-2. They are „non-combustible“. Their reaction to fire is classified as A2-s1,d0 in accordance with EN 13501-1.

Rigidur® H (A1)

Gypsum fibreboard GF-C1-I-W2 in accordance with EN 15283-2

Rigidur H (A1) gypsum fibreboards are standardized construction products in accordance with EN 15283-2. They are „non-combustible“. Their reaction to fire is classified as A1 in accordance with EN 13501-1.

Rigidur® Hsd

Rigidur® Hsd gypsum fibreboard in accordance with EN 15283-2

Rigidur Hsd gypsum fibreboard are standardized construction products in accordance with EN 15283-2. They are „non-combustible“. Their reaction to fire is classified as A2-s1,d0 in accordance with EN 13501-1.

1.3 Rigidur® gypsum fibreboard edge shapes

Standard shapes

4SK



Four-sided square edge

Applications

For butt joint installation and Joint Filling or Adhesive Joint Techniques

Special shapes

AK





Tapered longitudinal edges

Applications

For tapered edge joining techniques, i.e. filling of tapered long edges (with Rigips grid reinforcement strips, Rigips glass-fibre reinforcement strips or Rigips paper reinforcement strips)

1.4 Overview of Rigips® plasterboards (extract from range)

	Board thickness	Format (width x length)	Properties	Applications
Rigips® RF fireproof boards  VARIO edge (HRAK)	12.5 mm	1,250 x 2,000 mm ¹⁾ 1,250 x 2,500 mm 1,250 x 3,000 mm	Gypsum plasterboard acc. to DIN EN 520, type DF, made of a special, reinforced gypsum core encased in cardboard.	For the creation of hybrid walls, a combination of gypsum fibreboards and plasterboards for special requirements.
Rigips® RB construction boards  VARIO edge (HRAK)	12.5 mm	1,250 x 2,000 mm ¹⁾ 1,250 x 2,500 mm 1,250 x 2,600 mm 1,250 x 2,750 mm 1,250 x 3,000 mm	Gypsum plasterboard acc. to DIN EN 520, type A, made of a gypsum core encased in cardboard.	For the creation of hybrid walls, a combination of gypsum fibreboards and plasterboards for special requirements.

¹⁾ with chamfered transverse edge

1.5 Rigips® construction and fireproof board edge shapes

Standard shapes

VARIO®



half-rounded, tapered, longitudinal edge clad with board (HRAK)

Applications

Primarily for the filling of joints without reinforcement strips, but can also be filled with reinforcement strips.

1.6 Accessory range for wall, ceiling and roof structures



Product name	Rigidur® Nature Line joint adhesive ¹⁾	Rigidur® joint adhesive ¹⁾	Rigidur® joint adhesive ¹⁾ supplied in a flowpack
Product specification	Single-component joint adhesive free from solvents and other hazardous substances, in paste form	Single-component, solvent-free, poly-urethane-based joint adhesive, in paste form	Single-component, solvent-free, poly-urethane-based joint adhesive in paste form
Application area	For bonding Rigidur boards using the Adhesive Joint Technique	For bonding Rigidur boards using the Adhesive Joint Technique	For bonding Rigidur boards using the Adhesive Joint Technique
Container size	310 ml / cartridge	310 ml / cartridge	580 ml / flowpack
Consumption	Approx. 14 ml / joint m	Approx. 14 ml / joint m	Approx. 14 ml / joint m
Coverage	Approx. 25 m ² / cartridge for large-format boards	Approx. 25 m ² / cartridge for large-format boards	Approx. 45 m ² / Flowpack for large-format boards
Processing time	Approx. 10 minutes	Approx. 10 minutes	Approx. 10 minutes
Processing temperature	7 - 25 °C	5 - 30 °C	5 - 30 °C
Storage period	12 months unopened	12 months unopened	12 months unopened
Storage	Frost-free	not frost-sensitive	not frost-sensitive

¹⁾ Please note that for the products offered with an obligation to label the regulations valid in the respective country must be observed. If necessary, a separate national labeling and approval is required before sale



Processing tips

We recommend the Rigips ReadyMix pistol with matching attachable nozzles for the application of Rigidur joint adhesive supplied in a flowpack.





Product name	Rigips® grid reinforcement strips	Rigidur® reinforcement strips	VARIO® joint filler	Rigidur® Fix drywall screws
Product specification	Self-adhesive grid reinforcement strips, 48 mm wide	Special reinforcement tape for joints in wall and ceiling structures	Polymer-modified material in accordance with EN 13963/ Type 4B	Made of steel, specially treated, black phosphated
Application area	Reinforcement strips for use in the tapered-edge joining technique	To reduce the risk of cracking in the following coatings	For filling joints between Rigidur boards and for the covering of fasteners	For fastening Rigidur boards 3.5 x 30 mm 3.5 x 40 mm 3.5 x 50 mm 3.5 x 40 mm drill bit*
Container size	90 m/roll	50 m/roll	5 kg/bag 25 kg/sac	1,000 units/carton 500 units/carton*
Consumption	0.8 m/m ²	0.8 m/m ²	Approx. 0.3 kg/m ² (filled joint)	20 units/m ²
Coverage	110 m ² /roll for large-format boards	60 m ² /roll for large-format boards	Approx. 16 m ² /bag Approx. 80 m ² /sac	50 m ²
Processing time	-	-	Approx. 40 minutes	-
Processing temperature	Not below 5 °C	Not below 5 °C	Not below 5 °C	-
Storage period	12 months unopened	-	12 months unopened	-
Storage	Dry	Dry	Dry and frost-free	Dry

Chapter contents

2.1	Storage and transportation	20
2.2	Board processing	22

2.1 Storage and transportation

Storage

- Store Rigidur boards horizontally on a flat surface (pallet) or on timbers with a maximum spacing of 350 mm.
- The load-bearing capacity of the substrate must be taken into account when selecting a storage location for boards (e.g. 1 pallet with 70 Rigidur H small-format boards weighs approx. 1.2 t.).

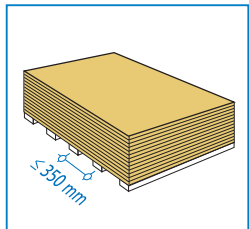

How to remove boards correctly from a stack

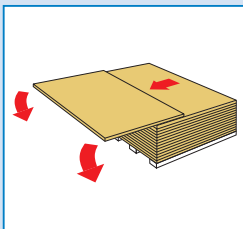

Push the long edge of the board from the stack and tip it

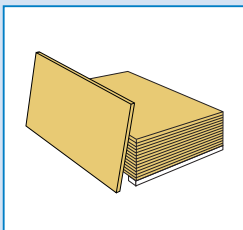

Stand the board upright on the long edge

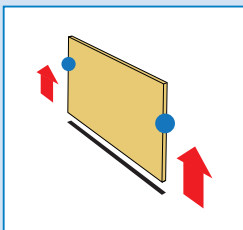

Carry the board upright

- Boards should be protected from moisture (rain, snow) and allowed to acclimatize to the ambient temperature – which should not be lower than +5 °C – before installation. Rapid, sudden heating should be avoided. Heating using gas burners may result in condensation forming on cold wall surfaces; sufficient ventilation must therefore be ensured.

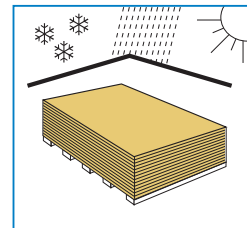

Transportation

- If using forklift trucks to transport boards, the prongs must be at least 1 m apart.
- Individual boards should be transported upright. Otherwise, Rigidur gypsum fibreboards should be moved using suitable means of transport (lift truck or panel cart).

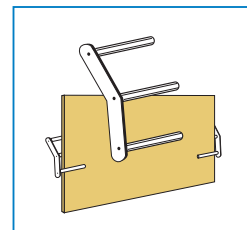

! Notes

- Should Rigips boards briefly become damp, they must be allowed to dry out completely before installation.
- The boards should be separated to enable drying.
- If damp boards are stored upright, permanent deformation may occur.
- Rigidur boards and corresponding accessories such as joint filler or bonding compound should always be kept dry and stored inside buildings.

2.2 Board processing

Cutting

- Rigidur H gypsum fibreboards can easily be processed using standard wood and drylining tools. They should be laid flat on a level surface, a stack of other boards or a cutting table.
- Rigidur H boards can also be scored with a knife and snapped against the stack of remaining boards. It is not necessary to use a special board cutter. A standard knife with a hardened blade is quite sufficient. It is also not necessary to score the reverse of the boards.
- Boards can easily be cut to size using circular hand saws, preferably plunge saws with an appropriate extraction system. The optimum rotation speed and blade selection should be determined on the basis of the saw used in each case.
Tip: Saw blades with 1.8 - 2.2 mm wide alternate tothing deliver good results.
- Rigidur can easily be drilled, ground, rasped and milled. Use a jig saw to create curves.

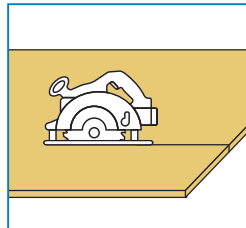
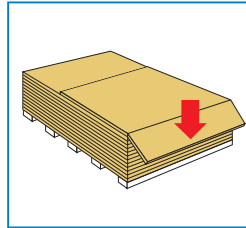
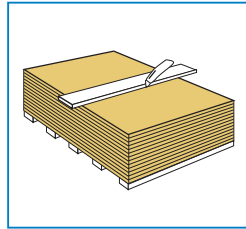

Processing note

- Rigidur boards with rough, broken edges can only be filled, not bonded.
- Rigidur boards with precisely cut edges can be installed using the Adhesive Joint Technique.

Cut-outs

- Cut-outs, e.g. for cavity wall sockets or pipe fairleads, should be measured out, drawn onto the board and cut using a cavity wall core drill, keyhole saw or jig saw.
- Cut-outs for pipes should be made at least 10 mm larger than the diameter of the pipe.
- The gaps should be filled appropriately in accordance with the relevant moisture/sound insulation and fire protection specifications.

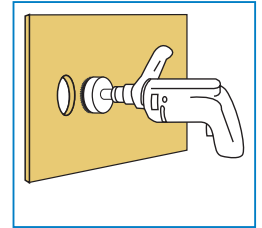
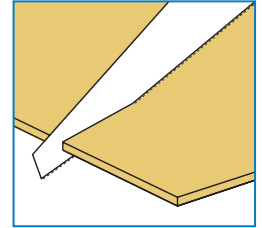

Chapter contents

3.1	Construction site conditions	26
3.2	Construction in winter	27

3.1 Construction site conditions

Interior construction using plasterboard systems has now reached a very sophisticated level in terms of processing. To prevent any errors and ensure clarity with respect to general construction conditions when installing plasterboard systems – i.e. to ensure quality – the following recommendations and notes are provided for craftspeople.

- Plasterboard panelling should not be installed in buildings where the relative **humidity exceeds 80%** on a long-term basis.
- **After installation**, plasterboard systems should be protected from long-term exposure to moisture.
- **Sufficient ventilation** should also be ensured in buildings after the completion of installation work.
- **Filling work** may only be performed once major changes in the length of the plasterboards as a result of moisture and temperature level fluctuations are no longer expected.
- When performing **filling work**, the material / room temperature may not fall below + 5 °C.

3.2 Construction in winter

- Rapid, sudden heating of rooms should be avoided as changes in board length may cause stress cracks.
- Hot or warm air should not be blown directly onto the surfaces of plasterboards.
- Sufficient ventilation must be ensured.

! Notes

- Plastering and flooring work generally lead to a significant increase in relative humidity. Thorough and even ventilation must therefore be ensured.
- Wet screeds, mastic asphalt and wet plasters should be installed before installing gypsum fibreboards. If it is not possible to complete these tasks in this order, at least the joint filling should be carried out afterwards to avoid any cracking in the joints.

Chapter contents

4.1	Butt joint installation	31
4.2	Filler preparation	32
4.3	Filled joint without reinforcement strips	34
4.4	Filled joint with grid reinforcement strips	35
4.5	Filled joint with glass-fibre or paper reinforcement strips	36
4.6	Adhesive Joint Technique	38
4.7	Practical tips for special situations	40

Depending on individual applications and processing, Rigidur gypsum fibreboards allow a range of different joining techniques: butt joint installation, Tapered Edge Joint Technique, Adhesive Joint Technique and Joint Filling Technique. Rigidur fabric tape should be used for joints with high requirements in terms of crack resistance.

Processing notes

Joint filling:

- The facade must be unbroken and any wet screed / plaster already applied as long-term exposure to moisture can prevent the filled joint drying out and may cause joints to swell.
- Rigidur gypsum fibreboards which have become damp may only be filled after they have dried out completely.
- Mastic asphalt floors must be installed before filling as cracks may otherwise occur in the joints due to thermal reaction.

Creating horizontal joints

- If it is not possible to use only full-size boards, any necessary horizontal joints should be located in the upper section of the wall.
- If horizontal joints are included in single-layer wall facings, they must be at least 400 mm apart.
- With multiple layers of panelling, the joints in the different layers should be offset (200 mm).
- Fill the 5 to 7 mm joints (Joint Filling Technique) with VARIO joint filler.

Alternatively: Butt joint installation using the Adhesive Joint Technique. (see also Adhesive Joint Technique) - Both the Joint Filling Technique and the Adhesive Joint Technique can be used to create horizontal joints between boards with tapered edges.

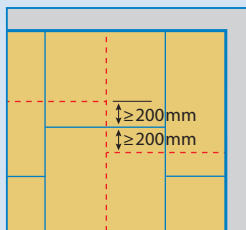

Horizontal joints in 2-layer panelling

— 1st layer
— 2nd layer

4.1 Butt joint installation

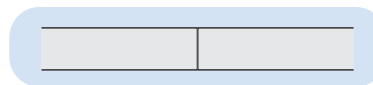

Butt joints

Boards can be butt jointed where the Rigidur gypsum fibreboards have factory-cut edges or edges that have been cut using a circular saw and guide rail. It is not necessary to bond or fill the first layer of boards where they are covered by a further panelling layer.



Processing note

When installing two layers of panelling, the Rigidur gypsum fibreboards should be installed with offset joints. One of the joining techniques described below should be used for the second layer.

4.2 Filler preparation

Stirring the filler has a significant effect on subsequent behaviour during installation and the results of the work. It is therefore essential that the following points are observed:

- Mixing proportions: 5 kg VARIO joint filler to approx. 2.5 l water.
- Use clean containers, tools and water as processing times may otherwise be impacted.
- Do not use any further additives.
- Never add warm water.
- Do not mix more filler than can be used in the stated processing time.
- Sprinkle the dry material into the water by hand or from the bag until areas of powder start to build up on the surface. This prevents the formation of lumps and ensures the right consistency.
- For optimum results it is essential to observe the recommended soaking time of approx. 3 minutes.
- Following the soaking time, mix the joint filler into a smooth mass.



Processing notes

- Rigips mixing buckets include marking lines indicating the required amount of water for VARIO joint filler.
- For preliminary filling the filler should be slightly stiffer as this has a positive effect on sink characteristics.

- The filler thickens during stirring and takes on a suitable consistency for application.
- Filler that is too stiff can be thinned with water. The instructions on the packaging must always be observed.
- Material which has already hardened should no longer be used or "diluted" by adding water. "Stretching" the filler is not permitted as this may result in joint cracking.
- The prepared joint filler should be thick enough so that it does not slip off a trowel when it is turned over.



Processing note

The processing instructions on the VARIO joint filler packaging must be observed.



4.3 Filled joint without reinforcement strips

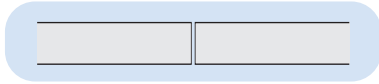

Boards laid with a joint gap of 5-7 mm

Lay the boards with a joint width of 5 to 7 mm. Ensure they are free from dust and wet them before filling.



Preliminary filling: Apply VARIO joint filler with a scraper or smoothing trowel at right angles to the joint and level with the surface. Fill holes/defects and cover screw heads with joint filler.



Subsequent filling work: Further filler may only be applied once the previous layer has fully hardened. Use the same material as for preliminary filling or Rigips ready filler (ProMix Finish).



Completely filled joint (from above) with a flat surface finish.



4.4 Filled joint with grid reinforcement strips

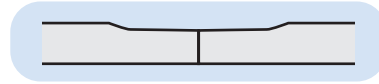

Butt jointed, tapered-edge joints

Butt joint the tapered edges together and fasten them. Ensure the tapered edges are free from dust and remove any excess material around screws. Then apply the self-adhesive Rigips grid reinforcement strips directly onto the tapered edges.



Preliminary filling: Apply VARIO joint filler with a smoothing trowel and level to the height of the edge.



Subsequent filling work: Further filler may only be applied once the previous layer has fully hardened. Use the same material as for preliminary filling or Rigips ready filler (ProMix Finish).



Smooth joint levelled to the board surface with screw heads and any surface defects filled.

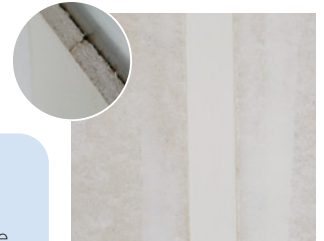

Processing notes

Transverse edges are to be executed in the same way as the selected joint technique (filler/adhesive joint).

4.5 Filled joint with glass-fibre or paper reinforcement strips

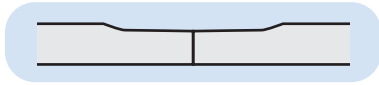

Butt jointed, tapered-edge joints

When adding reinforcement strips to filled joints between Rigidur H boards with tapered edges ...

... Rigips glass-fibre reinforcement strips or Rigips paper reinforcement strips may be used.

Fill the longitudinal and transverse joints with VARIO joint filler at right angles to the joint and level with the surface **1**.

Lay the reinforcement strips in the filler **2**...

... and then smooth the filler over without applying further material **3**.

Use VARIO joint filler or alternatively ProMix Finish for subsequent filling. Do not apply further filler until the preliminary layer is dry **4**.

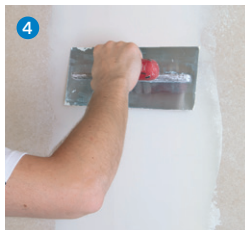
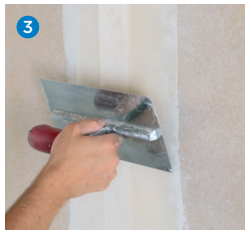

Processing notes



In areas where greater stresses are expected (e. g. in wooden structures or in combination with mineral surface coatings and thin plasters in accordance with manufacturer recommendations) we recommend using Rigidur fabric tape.

Apply a thin layer of VARIO joint filler over the hardened finished joint (chapter 4.3–4.6). **1**

Alternatively, Rigidur fabric tape can be applied to the dry and primed filled joint using Rigidur Nature joint glue or wood glue.



Lay the Rigidur fabric tape in the prepared thin filler layer or adhesive layer **2**.



Smooth the filler over the Rigidur fabric tape without applying further material **3**.



VARIO joint filler or ProMix Plus should also be used for subsequent filling. Do not apply further filler until the preliminary layer is dry **4**.



4.6 Adhesive Joint Technique



Butt jointed, bonded, square-edged joints

The Adhesive Joint Technique should only be used for completely straight board edges, i.e. factory-cut edges or edges cut using a guided plunge saw. Rigidur joint adhesive must be used exclusively to ensure the joints are properly bonded.

Ensure the board edges are free from gypsum and other construction-related dust. Always apply the joint adhesive generously to the clean, dust-free short edge of the first installed board – never to the substructure.



Press the next board against the first leaving a joint gap of max. 1 mm. The joint adhesive must fill the entire joint when the boards are pressed together.

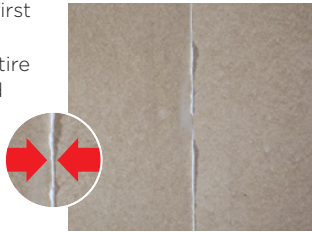

Excess joint adhesive will be squeezed out of the joint and can be removed using a scraper once hard.



Joint adhesive consumption is approx. 14 ml per joint meter.

For a perfect appearance, screw heads and surface defects should be filled and the adhesive joint covered with a layer of VARIO joint filler or ProMix Finish ready filler once it has fully hardened.



Processing note

The processing instructions on the joint adhesive cartridges must be observed. We recommend the Rigidur ReadyMix pistol with matching attachable nozzles for the application of Rigidur joint adhesive supplied in a flowpack.



Notes

- Rigidur gypsum fibre boards must always be mounted on metal structures or wooden substructures.
- A component separation under the joint area must be carried out when Rigidur gypsum fibre boards are mounted on particle boards like OSB (e.g. by backing the joint areas with masking tape or painter's tape).

4.7 Practical tips for special situations

In addition to the filling of joints in flat wall surfaces or sloped roofs, areas in corners or joints with other components may also require filling.

Filling of fasteners

Before beginning filling work, check that the fasteners are properly counter-sunk. The heads of fasteners can be filled once board joints have been pre-filled. Any further filling of fasteners can then be performed during finishing work and ground off if necessary.



Corner joints to plaster, etc.

With joints to plaster, concrete or similar, Rigips TrennFix strips, which ensure straight separation of the different materials, should be applied before filling. The visible part of the Rigips TrennFix strip should be removed after filling.

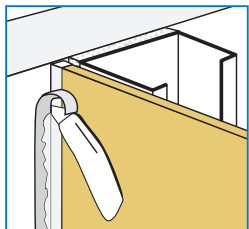

Corner joints with square / cut edges

Rigidur boards with square / cut edges should be installed approx. 5 mm apart. Rigips TrennFix strips should be applied in the same way as for corner joints. The visible part of the Rigips TrennFix strip should be removed after filling.

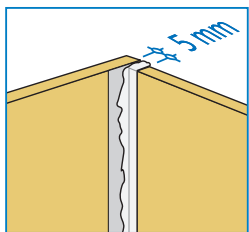

Outside wall corners with edge guards

Suitable edge protection should be applied to protruding wall corners and outside corners. This edge protection is realised using Rigips AquaBead in strip form with a fixed 90° angle or the flexible Rigips AquaBead Flex PRO, which can be used for various internal or external angles. Rigips AquaBead products are activated with water, applied and then covered with filler. For outside corners subject to extreme stresses, e.g. in clinics or care facilities (movement of beds), special, heavy-duty protection elements should be installed in the course of wall panelling.



Applied AquaBead edge protection

i Rigips information

All AquaBead products comprise a robust plastic core with a paper coating and have a starch-based adhesive on the reverse. The adhesive is activated with water which is applied using a spray bottle.



Rigips AquaBead Flex PRO – the flexible, self-adhesive edge protection for all angles

Rigips AquaBead – edge protection for 90° outside edges

Chapter contents

5.1	Rigidur Fix drywall screws/staples	44
5.2	Fastener penetration depth	46

5.1 Rigidur® Fix drywall screws/staples

Rigidur Fix drywall screws or resinated steel wire staples are used to fasten Rigidur boards to the substructure.

Rigidur Fix drywall screws are used to fasten Rigidur gypsum fibreboards to metal substructures. Rigidur Fix drywall screws are used to fasten boards to substructures (metal or wood) and other boards.

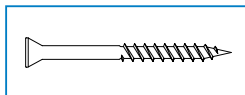

Staples can also be used on wooden substructures. Using staples is a particularly quick and thus highly cost-effective method.

Expansion staples are used to fasten Rigidur boards to each other, wedge staples to fasten the boards to wooden substructures

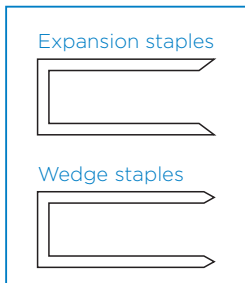

i Rigips information

Further details on fastener spacing for

- single-layer wall, ceiling and roof structures
- double-layer wall, ceiling and roof structures (fastening boards together) and on
- Metal substructures with double-layer panelling and fastening in the substructure
- Wooden substructures with double-layer panelling and fastening in the substructure can be found in the tables on the following pages.
- When using staples for static fastenings in wooden structures the “Planen und Bauen – Holzbau” (Planning and Construction – Wooden Structures“) documentation must be observed.

The particularly stable and hard surface allows fasteners to be inserted up to 10 mm from the edge of the board without the edges breaking.

i Processing notes

- For static reasons it is best to insert Rigidur Fix drywall screws on an offset basis (spacing of 20 to 30 mm).
- The minimum distance between screws and the board edge is ≥ 10 mm for gypsum fibreboards.
- A screw length should be selected that ensures the Rigips CW wall profiles are penetrated by at least 10 mm.
- Screw spacing for single-layer panelling: ≤ 250 mm.
- Expansion staples (e.g. Haubold staples) with a wire thickness of $d_n \geq 1.5$ mm should be used to fasten Rigidur gypsum fibreboards to each other. The shaft length should be 2-3 mm shorter than the total thickness of the two layers of Rigidur.
- Alternatively, Rigidur Fix 3.5 x 30 mm drywall screws may be used. See also section 5.2 “Fastener penetration depth” and the table on page 47.

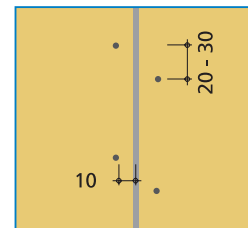

Offset screw fastenings

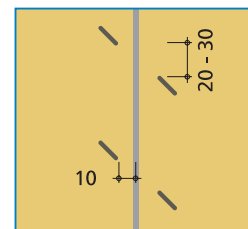

Offset staple fastenings

5.2 Fastener penetration depth

When inserting staples and screws, it is important to ensure the correct penetration depth. The staples and screws should not be inserted too deeply, nor should they protrude as it will otherwise be impossible to achieve a smooth finish when filling the fastening points. Staples and screws should be either flush with the board surface or countersunk by a maximum of 1.5 mm.

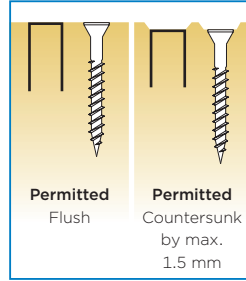

Processing note

When attaching Rigidur gypsum fibreboards to Rigips UA profiles (nominal thickness: 2 mm), Rigidur drywall screws with a drill bit (3.5 x 40 mm) should be used.



Fastener spacing for single-layer wall, ceiling and roof structures¹⁾

Sub-structure	Panelling	Rigidur® Fix drywall screws			Staples		
		Wall length/spacing mm	Ceiling and roof length/spacing mm	Wall length/spacing mm	Wall length/spacing mm	Ceiling and roof length/spacing mm	
Wood	Rigidur 10	30 / 250	30 / 170	35 / 200	33 / 150		
	Rigidur 12.5	30 / 250	30 / 200	35 / 200	35 / 150		
	Rigidur 15	40 / 250	40 / 170	38 / 200	38 / 150		
Metal	Rigidur 10	30 / 250	30 / 150	- / -	- / -		
	Rigidur 12.5	30 / 250	30 / 200	- / -	- / -		
	Rigidur 15	30 / 250	30 / 200	- / -	- / -		

¹⁾ With fireproof structures, the specifications of the general building code inspection certificate must be observed.

Fastener spacing for double-layer wall, ceiling and roof structures (Fastening boards together)

1st layer of	2nd layer of	Rigidur® Fix drywall screws			Expansion staples		
		Fastening to structure (as per the table for single-layer structures)	Fastening to board	Wall length/spacing mm	Wall length/spacing mm	Ceiling and roof length/spacing mm	
Rigidur® 10	Rigidur 10	22 ¹⁾ / 250	30 / 150	18-19 / 150	18-19 / 120		
Rigidur® 12.5	Rigidur 10	30 / 250	30 / 150	19-20 / 150	19-20 / 120		
Rigidur® 12.5	Rigidur 12.5	30 / 250	30 / 150	22-23 / 150	22-23 / 120		

¹⁾ 3.9 x 22 mm Rigidur drywall screws.

Metal substructure with double-layer panelling and fastening in the substructure

Fastening to the structure

Rigidur® Fix drywall screws

	Rigidur® Fix drywall screws		Staples	
	Wall length/spacing mm	Ceiling and roof length/spacing mm	Wall length/spacing mm	Ceiling and roof length/spacing mm
1st layer of Rigidur 10	30/750	30/300	-/-	-/-
2nd layer of Rigidur 10	40/250	40/200	-/-	-/-
1st layer of Rigidur 12.5	30/750	30/300	-/-	-/-
2nd layer of Rigidur 12.5	40/250	40/200	-/-	-/-
1st layer of Rigidur 15	30/750	30/300	-/-	-/-
2nd layer of Rigidur 15	50/250	50/200	-/-	-/-

Wooden substructures with double-layer panelling and fastening in the substructure

Fastening to the structure

Rigidur® Fix drywall screws

	Rigidur® Fix drywall screws		Staples	
	Wall length/spacing mm	Ceiling and roof length/spacing mm	Wall length/spacing mm	Ceiling and roof length/spacing mm
1st layer of Rigidur 10	30/750	30/300	35/600	35/300
2nd layer of Rigidur 10	40/250	40/150	45/200	45/150
1st layer of Rigidur 12.5	30/750	30/300	35/600	35/300
2nd layer of Rigidur 12.5	50/250	50/150	50/200	50/150

Chapter contents

6.1	Substrate requirements	52
6.2	Concealed installations	53
6.3	Mounting of electrical sockets	53
6.4	Installation	54

Rigidur drylining is wall panelling made of Rigidur gypsum fibreboards 10, 12.5 or 15 mm thick attached without an insulating layer directly to vertical structural components using Rifix bonding compound.

! Notes

- Separation joints in structural components should be continued in the drylining.
- Otherwise, expansion joints should be included at intervals ≤ 10 meters.
- Loads ≥ 15 kg should be fastened to load-bearing components.
- Drylining is not a suitable method for drying out damp walls!
- Filling work may not be performed immediately after installing Rigidur gypsum fibreboards as drylining. Filling may only be undertaken once the Rifix bonding compound has fully set and dried out.

6.1 Substrate requirements

- The substrate must be free of formwork oil, dry, not likely to shrink, frost-free, able to bear a sufficient load and protected from rain and rising damp.
- Lime plaster is not a suitable substrate (remove!).
- Fresh concrete must be at least 28 days old and dry before installation.
- Smooth substrates (e.g. concrete) should be pre-treated with Rikombi Kontakt.
- Highly absorbent substrates should be wetted in advance or pre-treated with Rikombi primer to reduce absorbency.
- Tiles and wallpapered / plastered surfaces may only be used as substrates following detailed inspection of adhesion / load-bearing capacity and cleaning!
- Joints in the masonry must be flush filled.
- All necessary substrate pre-treatment must be tailored to the conditions at the specific construction site.

6.2 Concealed installations

All concealed installations must be mounted before attaching the boards. Branch boxes and electrical sockets should be installed so that they protrude from the wall by 20 mm (Rigidur 10, 12.5 and Rigidur 15).

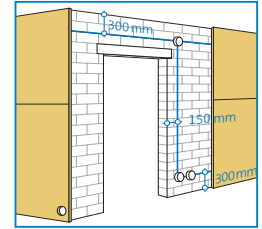

6.3 Mounting of electrical sockets

Electrical sockets should be mounted so that they protrude by the thickness of the drylining (by a correspondingly greater distance for composite boards).

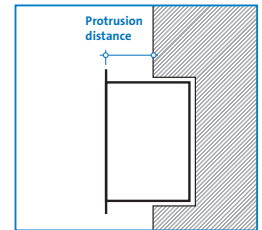

6.4 Installation

Stack Rigidur gypsum fibreboards which have been cut to size on a flat surface with the reverse facing upwards.

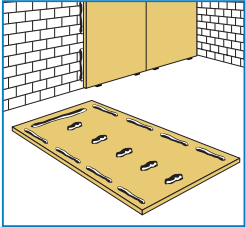

- Mix Rifix bonding compound to a stiff paste, then apply in lines along the board edges and in daubs across the surface.
- The daubs should be around 10-20 mm in size. In the event of greater surface irregularities, e.g. board strips may be used as guides.

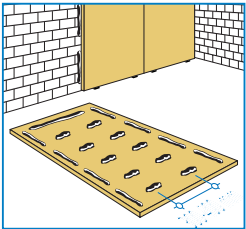

- Daubs should be approx. 100 mm in size and the gaps in between approx. 300 to 400 mm on Rigidur boards being used as a substrate for ceramic coverings e.g. tiles.

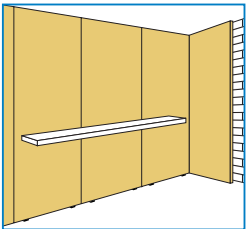

- After applying the Rifix bonding compound, stand the boards against the wall and push into place using a leveller or straight timber. Make sure they are aligned vertically and flush with joints 5 to 7 mm wide (Joint Filling Technique).

- Once the wall structure has fully dried, it should be filled with VARIO joint filler.

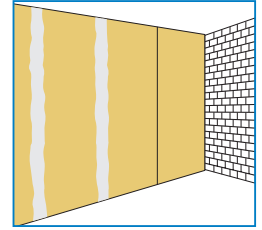

Material requirements per m² (WB01RH)

Rigidur H 10 / 12.5 / 15	1.0 m ²
Rifix bonding compound	5.0 kg
VARIO joint filler	0.2 kg



Processing notes

- The Adhesive Joint Technique is not suitable for drylining as it would prevent the Rifix bonding compound from drying fully.
- Apply Rifix bonding compound ≥ 10 mm thick across the entire surface in the vicinity of window reveals, wash basins, brackets, chimney cladding, etc. Chimney cladding may not exceed a maximum temperature of 45 °C.



Rigips information

Further information on the systems can be found at rigips.de/WB01RH or accessed directly via the QR code shown.



Chapter contents

7.1	Wall facings with substructures fastened to solid walls	58
7.2	Free-standing wall facings	61
7.3	Wall facings anchored to solid walls using wooden laths	63

7.1 Wall facings with substructures fastened to solid walls

This type of wall facing represents an ideal solution for uneven walls and for improving heat and sound insulation.

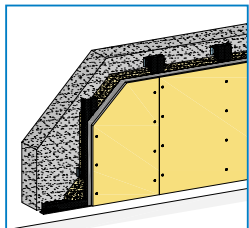

Substructure

The substructure may comprise:

- RigiProfil MultiTec UW/ CW 50 or
- RigiProfil MultiTec CD 60/ 27
- Rigips adjustable stirrups with 30, 45, 60 or 90 mm shafts.

Installation

All cables should be laid before installation. Water pipes on exterior walls may not run through the insulating layer due to the risk of frost.

Note

Profiles should be cut to size using plate shears, guillotine shears, nibblers or metal circular saws – never use an angle grinder, as the burning will destroy the corrosion protection.

- Stick Rigips felt joint seal to the reverse of the Rigips adjustable stirrups and dowel them to the wall.
- The vertical spacing between the Rigips adjustable stirrups should be $\leq 1,250$ mm for metal profiles.
- Stud spacing:
 - Stud spacing for Rigidur large-format boards ≤ 625 mm
 - Stud spacing for Rigidur small-format boards ≤ 500 mm.
- Stick Rigips felt joint seal to the reverse of Rigips UW 50 or UD 28 (for CD 60/ 27) connecting profiles and fasten them firmly to the floor and ceiling using impact or nail dowels at intervals of $\leq 1,000$ mm.
- Position the Rigips wall profiles, fasten them to the Rigips adjustable stirrups using 3.8 x 11 mm screws and insert insulating material.

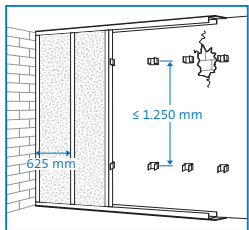

- A suitable vapour barrier (depending on calculation) should be attached to the substructure in accordance with the manufacturer's instructions. Use of a vapour barrier such as the ISOVER Vario KM duplex membrane is generally preferable (in accordance with the manufacturer's instructions). Precise installation, particularly in the joint area, must be ensured.
- Fastener spacing for one layer of panelling: ≤ 250 mm
- Fastener spacing for a double layer of panelling:
 - 1st layer ≤ 750 mm
 - 2nd layer ≤ 250 mm
- Panelling comprising Rigidur 10 or 12.5 mm should be fastened using 3.5 x 30 or 3.5 x 40 mm Rigidur Fix drywall screws at intervals of ≤ 250 mm.
- If it is not possible to use only full-size boards, any necessary horizontal joints should be located in the upper section of the wall.
- If horizontal joints are included in single-layer wall facings, they must be at least 400 mm apart.
- With multiple layers of panelling, the joints in the different layers should be offset (200 mm).
- Fill the 5-7 mm joints (Joint Filling Technique) with VARIO joint filler. Alternatively: Butt joint installation using the Adhesive Joint Technique.

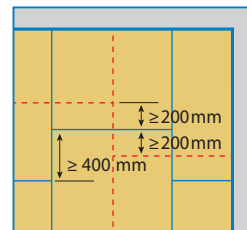
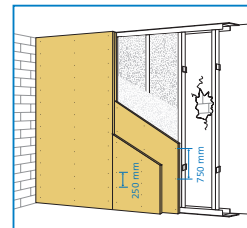
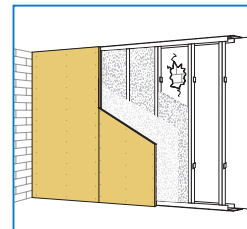

Horizontal joints in 2-layer panelling

- 1st layer
- 2nd layer

Material requirements per m² (VS21RH)

Rigidur H 10/12.5 (filled joint – Q2)	1.0 m ²
RigiProfil MultiTec UD 28	800 mm
RigiProfil MultiTec CD 60/27	1,800 mm
Rigips adjustable stirrups	2.2 units
Rigips Nail plugs	3.2 units
Rigips joint seal	1,200 mm
Cavity insulation	1.0 m ²
Rigidur Fix drywall screws 3.5 x 30 or 40 mm	10 units
Rigips Rigips drywall screws 3.8 x 11 mm	4.4 units
VARIO joint filler	0.2 kg

i Rigips information

Further information on the systems can be found at rigips.de / **VS21RH** or accessed directly via the QR code shown.

**7.2 Free-standing wall facings**

If the load-bearing capacity of the unfinished wall is insufficient or e.g. covered by installations, free-standing wall facings should be used.

Substructure

- RigiProfil MultiTec UW/CW 50, 75, 100 or 125
- Stud spacing: ≤ 625 mm

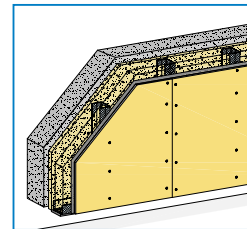
**! Note**

All cables should be laid before installation. Water pipes on exterior walls may not run through the insulating layer due to the risk of frost.

Installation

- Position the wall facing with an appropriate gap (≥ 20 mm).
- Stick Rigips felt joint seal to the Rigips UW connecting profiles and fasten them firmly to the floor and ceiling using impact or nail dowels at intervals of $\leq 1,000$ mm.
- Position and align the Rigips CW wall profiles and insert the insulating material. To prevent thermal bridges, the gap between the profile and outside wall should be completely filled with insulating material.

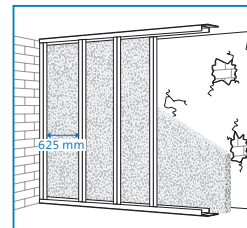

Arrangement of the substructure

! Note

Profiles should be cut to size using plate shears, guillotine shears, nibblers or metal circular saws – never use an angle grinder, as the burning will destroy the corrosion protection.

- Stud spacing:
 - Stud spacing for Rigidur large-format boards ≤ 625 mm
 - Stud spacing for Rigidur small-format boards ≤ 500 mm.
- Panelling comprising Rigidur 10 or 12.5 mm should be fastened using 3.5 x 30 mm Rigidur Fix drywall screws at intervals of ≤ 250 mm.
- Fill the 5 to 7 mm joints (Joint Filling Technique) with VARIO joint filler. Alternatively: Butt joint installation using the Adhesive Joint Technique.

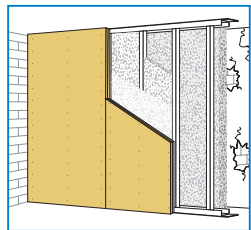

Installation of the insulating material/vapour barrier and attachment of the panelling

Material requirements per m²

Rigidur H 10/12,5	1.0 m ²
RigiProfil MultiTec CW	1,800 mm
RigiProfil MultiTec UW	800 mm
Rigips joint seal	1,200 mm
Rigips Nail plugs	1.6 units
Cavity insulation	1.0 m ²
Rigidur Fix drywall screws 3.5 x 30	11 units
Dowels	2 units
Rigidur joint adhesive (per joint meter)	15 ml
VARIO joint filler (Joint Filling Technique)	0.2 kg

7.3 Wall facings anchored to solid walls using wooden laths

Rigidur 10 or 12.5 mm gypsum fibreboards may be fastened to wooden laths where the masonry is uneven or the plaster is damaged.

- Dowel 50 x 30 mm wooden laths horizontally to the unfinished wall at intervals ≤ 800 mm for Rigidur large-format boards or ≤ 750 mm for Rigidur small-format boards (dowel spacing 1,000 mm).
- Any unevenness should be levelled out using wooden spacer blocks or spacer screws.
- Mineral wool may be installed in the cavity for heat and sound insulation purposes.
- A suitable vapour barrier (depending on calculations) must be applied to the substructure in accordance with the manufacturer's specifications. A vapour barrier for variable moisture levels (e.g. ISOVER Vario KM) (used in accordance with the manufacturer's specifications) is generally preferred. Precise installation is essential, particularly in joint areas.
- Fasten the 10 or 12.5 mm Rigidur gypsum fibreboards into place using Rigidur Fix drywall screws (length: 30 mm) at intervals ≤ 250 mm.
- Alternatively, steel wire clips may be used. See the "Fastener spacing for double-layer wall, ceiling and roof structures" in section 5.2

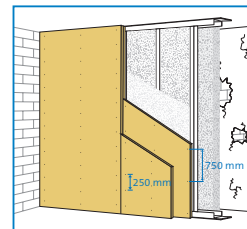
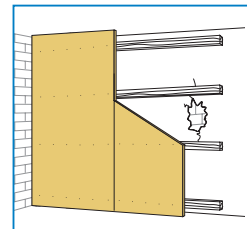

! Notes

- Component separation joints should be continued.
- Otherwise, expansion joints should be included at intervals ≤ 10 m.
- It should be reviewed whether a vapour barrier is necessary for all insulated wall facings.

Chapter contents

8.1	Rigidur shaft walls	66
8.2	Hybrid shaft walls	68

8.1 Rigidur® shaft walls

Metal substructure

(2- or 4-sided)

- RigiProfil MultiTec UW: UW 50, UW 75, UW 100 for floor and ceiling joints and
- RigiProfil MultiTec CW: for wall joints, fastened with nail dowels.
- Joint seals:
Rigips joint seals should be inserted behind all connecting profiles.
- RigiProfil MultiTec CW: CW 50, CW 75, CW 100, stud spacing: 625 mm.

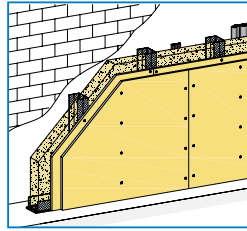

! Notes

- Profiles should be cut to size using plate shears, guillotine shears, nibblers or metal circular saws – never use an angle grinder, as the burning will destroy the corrosion protection.
- Component separation joints should be continued.
- Otherwise, expansion joints should be included at intervals ≤ 10 m.

Cavity insulation

- Mineral wool in accordance with requirements (see system descriptions).

Panelling

- Two to four layers, see system overview

Fastening

- Double-layer panelling:
 - 1st layer with Rigidur Fix 3.5 x 30 mm drywall screws at intervals of 500 mm,
 - 2nd layer with Rigidur Fix 3.5 x 40 mm drywall screws at intervals of 250 mm.
 - Alternatively: 1st layer with Rigips Rigidur Fix 3.5 x 30 mm drywall screws at intervals of 250 mm, 2nd layer with 30 mm steel wire staples at intervals of 150 mm.

- Triple-layer panelling:
 - 1st layer with Rigidur Fix 3.5 x 30 mm drywall screws at intervals of 500 mm,
 - 2nd layer with Rigidur Fix 3.5 x 40 mm drywall screws at intervals of 250 mm,
 - 3rd layer with Rigidur Fix 3.5 x 40 mm drywall screws or alternatively with 30 mm steel wire staples at intervals of 150 mm.

Filling

- Fill joints, including surrounding connecting joints, with Rigips VARIO joint filler. The first two layers of boards may be butt jointed; filling work is unnecessary in this case.

Material requirements per m² (SW12RH)

Rigidur H 12.5	1.0 m ²
Rigidur H 10	1.0 m ²
RigiProfil MultiTec CW 50	1,800 mm
RigiProfil MultiTec UW 50	800 mm
Rigips Nail plugs 6 x 40 mm	1.6 units
One-sided, self-adhesive Rigips felt joint seal, 50 mm	1,200 mm
Rigidur Fix drywall screws 3.5 x 30 mm, for 1st layer	6 units
Rigidur Fix drywall screws 3.5 x 40 mm, for 2nd layer	12 units
VARIO joint filler	0.2 kg



i Rigips information

Further information on the systems can be found at rigips.de/SW12RH or accessed directly via the QR code shown.

8.2 Hybrid shaft walls

Hybrid shaft walls comprise one or two layers of Rigidur H gypsum fibreboard panelling covered by a top layer of Rigips fireproof boards.

Metal substructure

(2- or 4-sided)

- RigiProfil MultiTec UW: UW 50, UW 75, UW 100 for floor and ceiling joints and
- RigiProfil MultiTec CW: for wall joints, fastened with nail dowels.
- Joint seals: Rigips joint seals should be inserted behind all connecting profiles.
- RigiProfil MultiTec CW: CW 50, CW 75, CW 100, stud spacing: 625 mm.

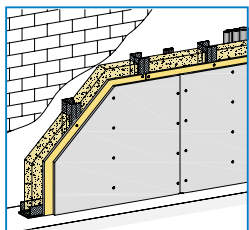

! Notes

- Profiles should be cut to size using plate shears, guillotine shears, nibblers or metal circular saws – never use an angle grinder, as the burning will destroy the corrosion protection.
- Component separation joints should be continued.
- Otherwise, expansion joints should be included at intervals ≤ 10 m.

Cavity insulation

- Mineral wool is not necessary in terms of fire protection requirements.

Panelling

- Two to three layers (see system overviews). The joints in the individual layers should be offset.

Fastening

- Double-layer panelling:
 - 1st layer with Rigidur Fix 3.5 x 30 mm drywall screws at intervals of 500 mm
 - 2nd layer with Rigidur Fix 3.5 x 40 mm drywall screws at intervals of 250 mm.

- Triple-layer panelling:
 - 1st layer Rigidur H with Rigidur Fix 3.5 x 30 mm drywall screws at intervals of 500 mm
 - 2nd layer Rigidur H with Rigidur Fix 3.5 x 40 mm drywall screws at intervals of 250 mm
 - 3rd layer: Rigips fireproof boards with 30 mm steel wire staples at intervals of 150 mm.

Filling

- Fill joints, including surrounding connecting joints, with Rigips VARIO joint filler.
- It is unnecessary to fill the 1st layer of Rigidur H.

Material requirements per m² (SW12RHRF)

Rigidur H 12.5	1.0 m ²
Rigips fireproof boards	1.0 m ²
RigiProfil MultiTec CW 50	1,800 mm
RigiProfil MultiTec UW 50	800 mm
Rigips Nail plugs 6 x 40 mm	1.6 units
One-sided, self-adhesive Rigips felt joint seal, 50 mm	1,200 mm
Reinforcement strips (where necessary)	1,450 mm
Rigidur Fix drywall screws 3.5 x 30 mm, for 1st layer	12 units
Rigips HartFix drywall screws 3.8 x 25 mm, for 2nd layer	12 units
VARIO joint filler	0.3 kg



i Rigips information

Further information on the systems can be found at rigips.de/SW12RHRF or accessed directly via the QR code shown.

Chapter contents

9.1	Wall systems: Metal single stud partition walls	72
9.1.1	Installation order of metal single stud partition walls	74
9.2	Extending Rigips CW wall profiles	77
9.3	Panelling	78
9.4	Floor and ceiling joints	79
9.5	Mounting of pipe and cable fairleads, electrical sockets, etc.	81
9.6	Double-layer panelling	86
9.7	Anti-burglary protection in drywall construction applications	87
9.7.1	Rigips anti-burglary single stud partition walls - RC 2/RC 3	87
9.8	Rigips hybrid walls	90
9.8.1	Rigips GF Top hybrid wall	90
9.8.2	Rigips GK Top hybrid wall	93
9.9	Wall systems: Metal double stud partition walls	96
9.10	Wall systems: Metal double stud partition walls as installation walls	98
9.11	Installation of sanitary equipment	100
9.12	Wall systems: Wooden single stud partition walls	102
9.13	Wooden substructure / installation process	104
9.14	Wall systems: Wooden double stud partition walls	106

Non-load-bearing partitions are regulated in DIN 4103-1, DIN 18183 and special approvals. Rigips offers different sub-structure, cavity insulation and panelling system structures to meet all requirements.

9.1 Wall systems: Metal single stud partition walls

Metal substructure

- RigiProfil MultiTec UW: UW 50, UW 75, UW 100 as floor and ceiling joints
- RigiProfil MultiTec CW: CW 50, CW 75, CW 100, spacing between studs: usually 625 mm (500 mm for small-format Rigidur boards)
- Rigips LW wall profiles: LW 60/60 for corners
- Joint seals: All connecting profiles should be fitted with Rigips joint seals.

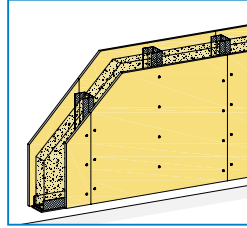

! Notes

- Component separation joints should be continued.
- Otherwise, expansion joints should be included at intervals ≤ 10 m.
- The RigiProfil MultiTec CW should be installed at intervals of max. 1,000 mm (but at least 3 fastening points).
- The starting point for inserting fasteners into the RigiProfil MultiTec UW or CW joint profiles is around 100 mm from the end of the corresponding profile.
- Do **not** screw the panelling to the Rigips UW profiles (ceiling/floor joints).

Cavity insulation

- The cavity insulation may be freely selected.
- However, where special sound insulation and fire protection requirements exist, the cavity insulation should be selected in accordance with the system overview.

Panelling

- Single- or double-layer panelling, depending on requirements: Rigidur 10/12.5/15

Material requirements per m² (MW11RH)

Rigidur H 12.5 (room-high boards)	2.0 m ²
RigiProfil MultiTec CW 50	1,800 mm
RigiProfil MultiTec UW 50	800 mm
Cavity insulation	1.0 m ²
Rigips Nail dowels	1.6 units
Rigips felt joint seals	1,200 mm
Rigidur Fix 3.5 x 30 mm drywall screws	20 units
VARIO joint filler	0.4 kg

i Rigips information

Further information on the systems can be found at rigips.de/MW11RH or accessed directly via the QR code shown.



9.1.1 Installation order of metal single stud partition walls

The metal substructure comprises galvanized sheet profiles (connecting and stud profiles).

! Note

Profiles should be cut to size using plate shears, guillotine shears, nibblers or metal circular saws – never use an angle grinder, as the burning will destroy the corrosion protection.

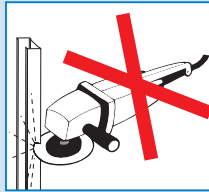

Marking

- Mark the position of the wall on the floor.
- Include door openings.
- Also mark the wall position on the ceiling.

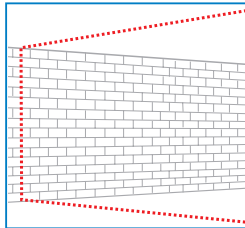

- Attach one-sided, self-adhesive Rigips felt joint seals to the RigiProfil MultiTec UW and fasten the profiles to the floor and ceiling using Rigips nail dowels at intervals of 1,000 mm.

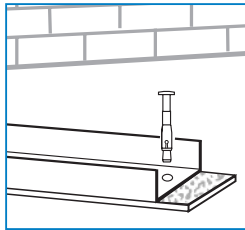

i Notes

Joint seals for sound insulation and fire protection

- Rigips joint seals with building material classification B2 e.g. felt, $d \leq 5$ mm. Seal joints flush with the boards using an appropriate joint filler material
- Rigips A1 mineral wool edge insulation strips, $d = 10$ mm, width = dependent on the profile

i Rigips information

Details on floor / ceiling joints can be found on page 79. Information on special wall heights and the necessary profile extensions can be found in section 9.2

Stud profiles

- Rigips CW profiles (studs) should be measured out so that they extend into the RigiProfil MultiTec UW (joint) mounted on the ceiling by at least 15 mm while leaving a gap to the profile of 10 to 20 mm.
- The centre-to-centre distance between the Rigips CW profiles should be 500 mm for small-format boards and ≤ 625 mm for large-format Rigidur boards.
- The Rigips CW profiles should be positioned with the closed side facing in the mounting direction (see detail image).

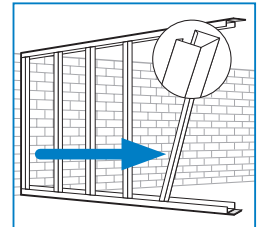
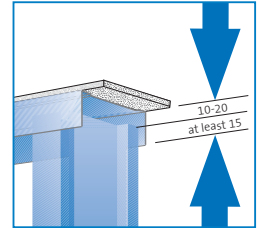

Processing notes

- When attaching the panelling, check that the RigiProfil MultiTec CW are firmly fixed to the Rigips connecting profile on the floor.
- Where extensions to CW profiles are necessary due to wall heights, please refer to section 9.2, page 77.

Panelling of the 1st wall side

- When installing one layer of panelling, the Rigidur gypsum fibre-boards should be installed working towards the closed profiles and with facing joints. If transverse joints are necessary, they should be positioned so that they are offset by ≥ 400 mm.

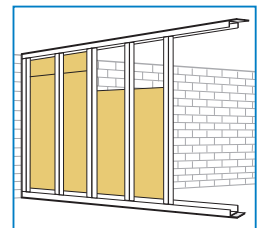

! Notes

- When installing one layer of panelling, the joints should face each other. Depending on the joint type selected, follow the corresponding instructions in the “Joining Techniques” section.
- When installing two layers of panelling, the lower layer may be butt jointed (see also the „Joining techniques“ section).

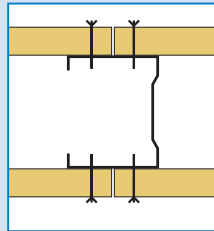

Cavity insulation

- After panelling the first wall side and adding any necessary electrical and sanitary installations in the wall cavity, insulation may be added to improve sound insulation and fire protection.
- The entire cavity should be insulated. Ensure that the insulating material cannot slip out of position.

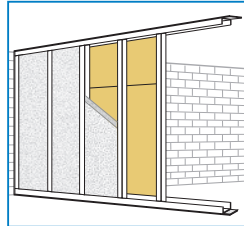

Panelling of the 2nd wall side

- The panelling must be installed with facing joints.
- Subsequent filling work on board / connecting joints and screw heads ensures final stability.

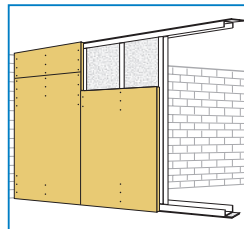

! Notes

- These interlaced sections should be filled with appropriate mineral wool to ensure that sound insulation and fire protection requirements are met.
- The butt joints of the extended CW studs should not all be at the same height!
- The max. height for the wall system should not be exceeded under any circumstances!

9.2 Extending Rigips® CW wall profiles

If the CW studs are too short for extra-high partition walls, they can easily be extended as follows depending on the height required:

Variant 1

- For walls ≤ 5 meters high, UW profile pieces (≥ 1.000 mm) can simply be fastened to the butt jointed ends of the CW stud profiles using blind rivets $\geq 3.2 \times 6$ mm inserted ≤ 40 mm from the joint. (See table).

Variant 1: Profile extensions

Profile size	Overlap [O] mm
	≥ 500
50	≥ 750
75	$\geq 1,000$
100	$\geq 1,250$
125	$\geq 1,500$
150	$\geq 1,500$

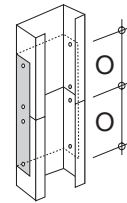

Variant 2

- For walls > 5 meters high, the ends of the CW stud profiles can simply be interlaced with CW profile pieces (≥ 1.000 mm) to form a box. These pieces should also be fastened using blind rivets $\geq 3.2 \times 6$ mm inserted ≤ 40 mm from the joint. (See table).

Variant 2: Profile extensions

Profile size	Overlap [O] mm
	≥ 500
50	≥ 750
75	$\geq 1,000$
100	$\geq 1,250$
125	$\geq 1,500$
150	$\geq 1,500$

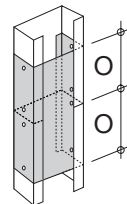

! Note

Profile extensions for walls with fire protection requirements on request.

9.3 Panelling

- Boards which are the same height as the room are generally recommended for panelling. This not only improves the physical properties of the partitions, but also reduces workload and material requirements with respect to cut-outs and filling work.
- When installing one layer of panelling, facing joints on the studs should be created.
- If it is not possible to use boards which are the same height as the room, the required horizontal joints should be located in the upper section of the wall.
- If there are multiple horizontal joints in one side of a single-layer partition, they must be at least 400 mm apart.
- With multiple layers of panelling, the joints in the different layers should be offset (200 mm).
- Board strips should not be less than approx. 500 mm wide.

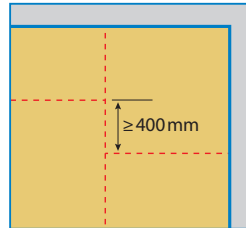
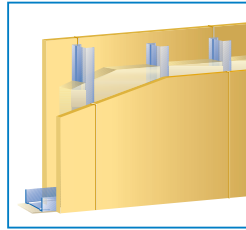

Horizontal joints in single-layer panelling

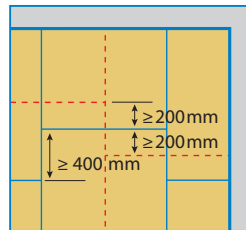

Horizontal joints in double-layer panelling

----- 1st layer
 ————— 2nd layer

Processing notes

- For single-layer panelling: Install the boards with facing joints, work towards the closed profile side.
- For double-layer panelling: The 1st layer may be butt jointed. The 2nd layer may be fastened to the 1st layer anywhere irrespective of the positioning of the studs.

To ensure problem-free joint filling on the partition walls in line with sound insulation and fire protection requirements, the minimum joint widths (5 mm) must be observed.

9.4 Floor and ceiling joints

- The bottom edges of partitions should ideally be fastened directly to the unfinished floor.
- Edge insulation strips should be inserted between floating floors and adjacent walls to prevent the transmission of footstep sound (use A1 mineral wool edge insulation strips for fireproof structures).
- If partitions with sound insulation requirements are to be installed on a floating floor, the floor must be separated from the Rigips UW wall profiles and residues removed.

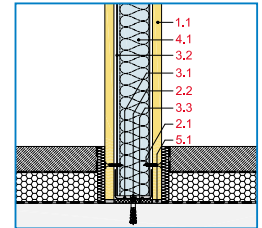

Joint to the solid floor

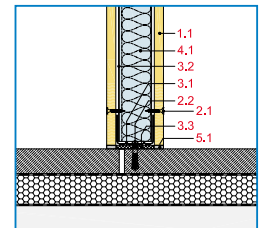

Joint to the screed with separating joint

- 1.1 Rigidur H panelling
- 2.1 Fastening in accordance with the system
- 2.2 Edge joint fastening
- 3.1 RigiProfil MultiTec ≥ UW 50 as a floor and ceiling joint
- 3.2 RigiProfil MultiTec ≥ CW 50 as a wall joint
- 3.3 Rigips joint seal
- 4.1 Insulation material in accordance with the system
- 5.1 E.g. VARIO joint filler

- The top edges of partitions should ideally be fastened to the slab.

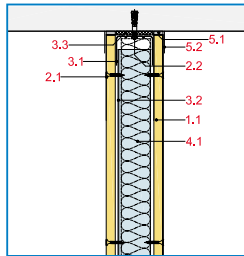

Joint to solid ceiling

- Separated joints to the ceiling should be used where the ceiling is expected to bend by more than 10 mm.

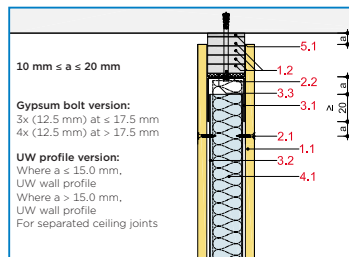

Separated joint to a solid ceiling

- 1.1 Rigidur H panelling
- 2.1 Fastening in accordance with the system
- 2.2 Edge joint fastening
- 3.1 RigiProfil MultiTec ≥ UW 50 as a floor and ceiling joint
- 3.2 RigiProfil MultiTec ≥ CW 50 as a wall joint
- 3.3 Rigits joint seal
- 4.1 Insulation material in accordance with the system
- 5.1 Filler, e.g. VARIO joint filler
- 5.2 Rigips reinforcement strips or alternatively Rigips TrennFix in accordance with processing guidelines



Rigips information

Further details on floor and ceiling joints can be found at rigips.de/MW11-D or accessed directly via the QR code shown.

9.5 Mounting of pipe and cable fairleads, electrical sockets, etc.

Cavity wall sockets which meet the requirements of the German Association of Electrical Engineers (VDE) regulation 0606 H and plastic-sheathed cables (e.g.: NYM) which require no mechanical protection should be installed in partition walls and suspended ceilings.

Cables should be laid after the first side of the panelling has been installed:

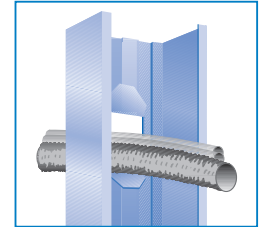

H-shaped cut-out in a metal stud

- With metal studs, the corresponding H-shaped cut-outs should be bent out accordingly (see image to the right). Cut-outs for electrical cables should be made at the same level throughout where possible.
- If installing cable bundles or pipes, please note that only a limited number of cut-outs can be made in the Rigips CW wall profiles. The number and size of the cut-outs is dependent on the height of the profiles (see table on page 83).
- Take care to ensure the insulation is not damaged when pulling cables through.

Processing notes

- Plate shears can be used to create the cut-outs.
- Notches (see image to the right) may be cut into the upper part of wooden studs.
- Round drill-holes should be cut into wooden studs for large cable openings. A cross-section of at least 15 mm on both sides must be retained.

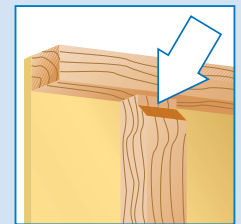

Notch in a wooden stud

! Notes on cut-outs

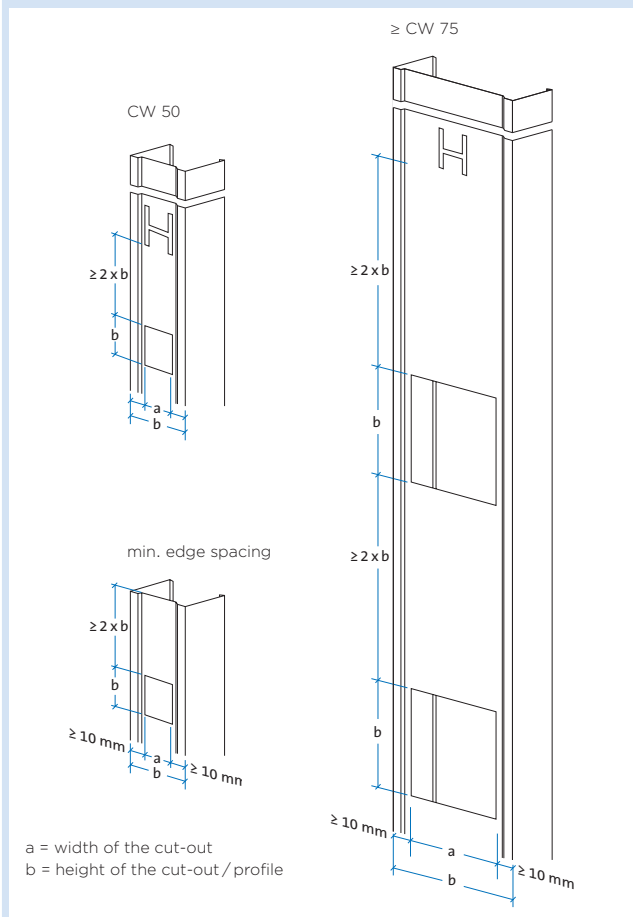

- A greater number of smaller openings may be possible – please inquire.
- The openings can be made in addition to the usual H-shaped cut-outs.
- Cut-outs in the profile flange are not permitted!
- Please note that the addition of installations may limit the effective thickness of the insulating material, which may in turn have a negative impact on sound insulation.
- Cut-outs in UA profiles are permitted as per the table on page 83. Please note however that cuts into slot areas are not permitted.

Number and size of cut-outs in CW and UA profiles		Number of additional cut-outs per stud		Cut-out size width (a) x height (b)		Min. spacing between cut-outs and min. gap to edge ($\geq 2 \times b$)		Panelling on each wall side	
Type of profile				mm	mm	mm	mm	mm	mm
CW 50	1		$\leq 30 \times \leq 50$	≥ 100 ³⁾	$\geq 18,0$		$\geq 18,0$		
CW 75	2		$\leq 55 \times \leq 75$	≥ 150	$\geq 12,5$		$\geq 12,5$		
CW 100	2		$\leq 80 \times \leq 100$	≥ 200	$\geq 12,5$		$\geq 12,5$		
CW 125	2		$\leq 80 \times \leq 125$	≥ 250	$\geq 12,5$		$\geq 12,5$		
CW 150	2		$\leq 80 \times \leq 150$	≥ 300	$\geq 12,5$		$\geq 12,5$		
UA 50	2		$\leq 30 \times \leq 50$	≥ 100 ³⁾	$\geq 18,0$		$\geq 18,0$		
UA 75	1		$\leq 55 \times \leq 75$	≥ 150	$\geq 12,5$		$\geq 12,5$		
UA 100	1		$\leq 80 \times \leq 100$	≥ 200	$\geq 12,5$		$\geq 12,5$		
UA 125	1		$\leq 80 \times \leq 125$	≥ 250	$\geq 12,5$		$\geq 12,5$		
UA 150	1		$\leq 80 \times \leq 150$	≥ 300	$\geq 12,5$		$\geq 12,5$		

³⁾ counts as the gap to the H-shaped cut-out

- An accurate opening for electrical sockets and switches can be cut using a core drill.
- Electrical sockets may in principle be installed anywhere in partitions subject to fire protection requirements but they should not be located directly opposite each other on the two sides of the wall. **1**.

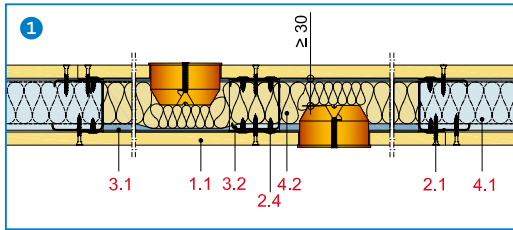

Mounting of an electrical socket in a partition wall with compressed mineral wool für F 30, melting point $\geq 1,000$ °C

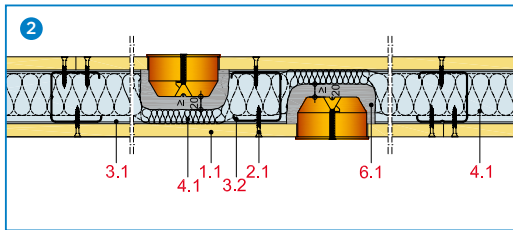

Mounting of an electrical socket embedded in plaster in a partition wall

- If electrical sockets are to be installed on both sides of the wall, they must be separated by at least one stud profile.
- When using mineral wool insulation with building material classification A in accordance with DIN 4102-1, a density of ≥ 30 kg/m³ and a melting point $\geq 1,000$ °C, the insulation may be compressed to ≥ 30 mm **1**. The insulation must extend above and below electrical sockets by at least 500 mm. Ensure that the insulation cannot slip out of position, e.g. by inserting an additional frame made of CW/UW profiles.

¹⁾ At least 80% cavity insulation comprising mineral wool with a melting point $\geq 1,000$ °C, building material classification A

- If this is not possible, electrical sockets should be embedded in plaster **2**.
- Electrical sockets should generally also be embedded in plaster when using other cavity insulation materials.
- In shaft walls, the depth of the electrical socket housing should generally correspond to the thickness of the panelling. In the installation shown in the adjacent illustration **3**, the entire block for the housing has been fastened into the prepared rebate edge of the shaft wall using appropriate Rigips drywall screws.

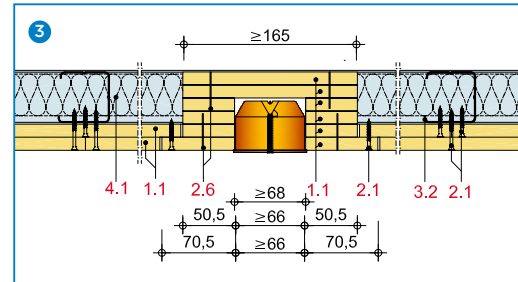

Installation of an electrical socket in a shaft wall with housing

! Note

Electrical sockets should not be installed directly opposite each other on the two sides of the wall for fire protection and sound insulation reasons; they should be separated by at least one stud.

- 1.1 Panelling
- 2.1 Rigips Fix drywall screws
- 2.6 Steel wire staples
- 3.2 RigiProfil MultiTec CW
- 4.1 Insulation material in accordance with the system
- 6.1 Filler, e.g. VARIO joint filler

9.6 Double-layer panelling

Double-layer panelling can be realised in one of two ways:

1. The bottom layer may be butt jointed without filling. The top layer of panelling should then be fastened anywhere to the bottom layer irrespective of the positioning of the studs using expansion staples or Rigidur Fix 3.5 x 30 mm drywall screws. Three rows of Rigidur Fix 30 mm drywall screws should be inserted all the way around the board edges and down the centre of the long axis of the board (screw intervals ≤ 250 mm). Alternatively, four rows of 22 mm expansion staples at intervals of ≤ 150 mm may be used.
2. If both layers are to be fastened to the studs, the same joint spacing should be maintained in both the first and second layers where the boards are of the same width (application for adhesive and filled joints). This is the only way to ensure that the fasteners are attached to the profile studs.

! Notes

- Before installing the next layer, the joint filler of the lower layer must have set or - where using ready fillers (ProMix Plus or ProMix Filler) - dried enough to ensure that the upper and lower layers of panelling do not stick together.
- To prevent cracking, the joints in the top layer of panelling may only be filled once both wall sides have been closed and no further changes in the length of the boards are expected.

For further information, please refer to the „Joining Techniques“ section.

- Screw spacing in double-layer panelling:
1st layer of panelling ≤ 750 mm
2nd layer of panelling ≤ 250 mm to the substructure

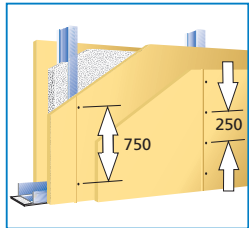

! Notes

- Additional information on fasteners and spacing can be found in the „Fasteners“ section.
- Do **not** screw the panelling to the Rigips UW profiles (ceiling / floor joints).

9.7 Anti-burglary protection in drywall construction applications

It is not only important to protect people and property from dangers such as fire, but also from undesirable „visits“. Rigips offers drywall structures with burglary-resistant properties in accordance with DIN EN 1627. This standard differentiates between various resistance classes (RC) for different perpetrator methods:

- RC 2:** The opportunist attempts to force the component using simple tools, e.g. screwdrivers, pliers and shims.
- RC 3:** The perpetrator attempts to gain access using stable lever tools, e.g. a crowbar.

9.7.1 Rigips anti-burglary single stud partition walls - RC 2 / RC 3

Metal substructure

- RigiProfil MultiTec UW: UW 50, UW 75, UW 100 for floor and ceiling joints and
- RigiProfil MultiTec CW: for wall joints fastened using nail plugs (6 x 35 mm) at intervals of 500 mm
- Joint seals: Rigips joint seals must be applied to all joint profiles.
 - without fire protection requirements: Rigips felt joint seals
 - with fire protection requirements: Rigips felt joint seals where protected by filler or panelling-thickness Rigips boards, otherwise A1 mineral wool joint seal, building material classification A in accordance with DIN 4102-1.

Cavity insulation

Insulation is not necessary for anti-burglary wall structures. Mineral wool panels or rolls (weight and thickness as stipulated by sound and fire protection requirements).

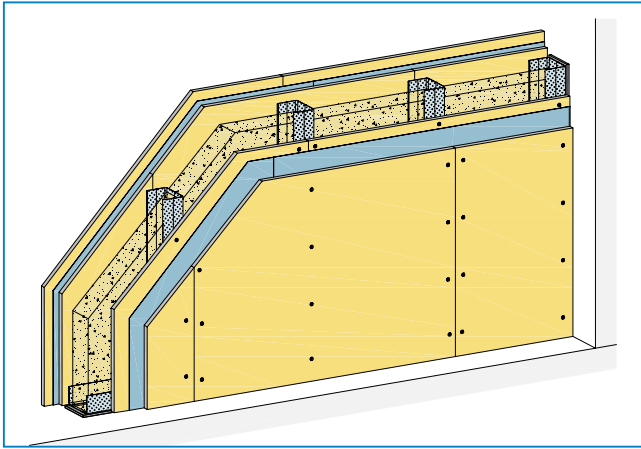

3-layer panelled metal single stud partition wall in accordance with resistance class RC2

An anti-burglary 3-layer panelled metal single-stud partition wall based on the requirements of DIN EN 1627 comprises:

- 1st and 3rd layer: Rigidur H with tapered edges/
Rigidur H Activ'Air / Rigidur H (A1).
- 2nd layer: Rigips steel panels

Installation:

- The first layer of Rigidur H boards is fastened to the CW stud frame using Rigidur Fix TN 3.5 x 30 mm drywall screws at intervals of 750 mm.
- The 2nd layer is the flat Rigips steel panel. It is butt jointed to the first layer of the Rigidur H boards using double-sided adhesive tape (installation aid).
- The second layer of Rigidur H boards is fixed to the steel panel layer using Rigidur Fix TB 3.5 x 40 mm drywall screws fastened to the CW stud frame at intervals of 250 mm.
- Once the installation is complete the joints are filled.

i Rigips information

Both the Joint Filling Technique and the Adhesive Joint Technique may be used. See the „Joining Techniques“ section on page 29.

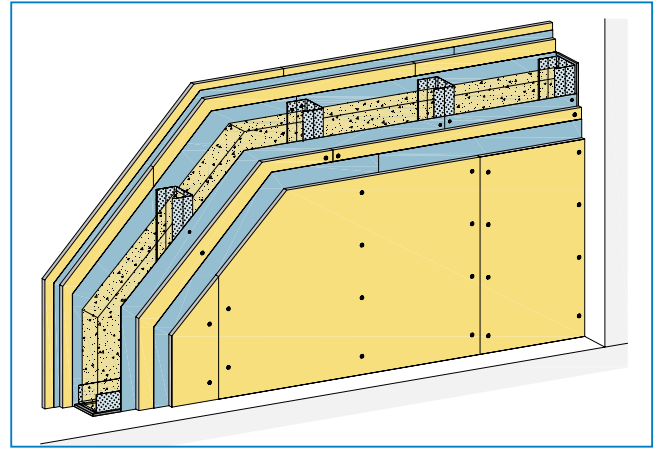

4-layer panelled metal single stud partition wall in accordance with resistance class RC3

An anti-burglary 4-layer panelled metal single-stud partition wall based on the requirements of DIN EN 1627 comprises:

- 1st and 3rd layer: Rigips steel panels
- 2nd and 4th layer: Rigidur H with tapered edges/
Rigidur H Activ'Air / Rigidur H (A1)

Installation:

- The 1st and 3rd layers each comprise a flat Rigips steel panel. The first layer is riveted directly onto the RigiProfil MultiTec and the third layer is butt jointed to the first layer of Rigidur H boards using double-sided adhesive tape (installation aid).
- The first layer of Rigidur H boards is fixed to the first steel panel layer using Rigidur Fix TB 3.5 x 40 mm drywall screws fastened to the CW stud frame at intervals of 750 mm.
- The second layer of Rigidur H boards is fixed to the second steel panel layer using Rigidur Fix TB 3.5 x 40 mm drywall screws fastened to the CW stud frame.
- Once the installation is complete the joints are filled.

i Rigips information

Both the Joint Filling Technique and the Adhesive Joint Technique may be used. See the „Joining Techniques“ section on page 29.

9.8 Rigips® hybrid walls

Rigips hybrid walls are e.g. partitions with a double layer of panelling comprising one layer of Rigidur H gypsum fibreboards and one layer of Rigips construction/fireproof boards.

- **Rigips® GK Top hybrid wall** (with the Rigips construction/fireproof boards on top): This structure offers extremely high stability and excellent sound insulation, making it particularly suitable for e.g. high-quality residential construction.
- **Rigips® GF Top hybrid wall** (with the Rigidur H gypsum fibreboards on top): This structure offers an extremely hard, smooth surface (comparable with the Q3 standard), making it particularly suitable for rooms subject to very high stresses.

9.8.1 Rigips GF Top hybrid wall

Metal substructure

- Rigips UW wall profiles: UW 50, UW 75, UW 100 for floor/ceiling joints and
- RigiProfil MultiTec CW: for the wall joints, fastened with nail dowels at intervals of 1,000 mm
- Joint seals: All connecting profiles should be fitted with Rigips joint seals.
 - **without** fire protection requirements: Rigips felt joint seals.
 - **with** fire protection requirements: Rigips felt joint seals as long as they are protected by filler or Rigips boards in the same thickness as the panelling. Otherwise, A1 joint seals made of mineral wool, building material classification A in accordance with DIN 4102-1 should be used.
- RigiProfil MultiTec CW: CW 50, CW 75, CW 100
- Stud spacing: usually 625 mm
- Rigips LW wall profiles: LW 60/60 for corners.

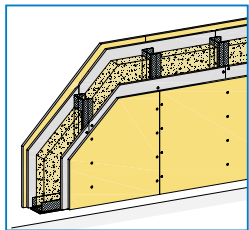

! Notes

- Profiles should be cut to size using plate shears, guillotine shears, nibblers or metal circular saws - never use an angle grinder, as the burning will destroy the corrosion protection.
- Position CW stud profiles with the closed side facing in the direction of installation.

Cavity insulation

Mineral wool as panels or rolls (weight and thickness according to requirements, see system descriptions).

Panelling of the first wall side - first layer of panelling

- The first layer of panelling (Rigips boards) should begin with a half-width board (625 mm). Use a power screwdriver to fasten the Rigips boards to the stud profiles with Rigips TN 25 mm drywall screws at intervals of ≤ 750 mm.
- If transverse joints are necessary, they should be positioned so that they are offset by at least ≥ 500 mm.
- Then use Rigips VARIO joint filler for filling work.

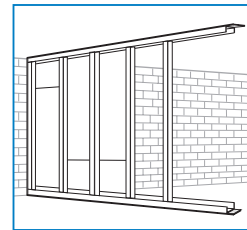

! Note

The first layer of panelling should generally be filled.

Panelling of the first wall side - second layer of panelling

- The second layer of panelling (Rigidur H 12.5) should begin with a full-width board (1,249 mm) because of the facing joints. The Rigidur H gypsum fibreboards in the second layer should be screwed into the CW profiles through the first layer using Rigidur Fix 40 mm drywall screws at intervals of ≤ 250 mm.
- If transverse joints are necessary, they should be positioned so that they are also offset by ≥ 500 mm; they should be located in the upper third of the wall where possible.
- The following joining techniques may be used here: Joints filled with Rigips VARIO joint filler, Rigidur H AK (tapered edge) joints or joints filled with Rigidur joint adhesive.

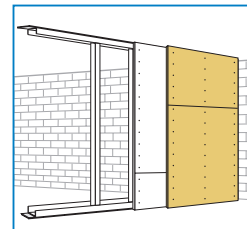

Cavity insulation

- After panelling the first wall side and adding any necessary electrical and sanitary installations in the wall cavity, insulation may be added to improve sound insulation and fire protection. The entire cavity should be insulated.
- Ensure that the insulating material cannot slip out of position.

Panelling of the second wall side

- The second wall side should also begin with a half-width board (625 mm) to ensure that the joints are not offset from those on the first wall side.
- Once the second wall side has been installed in the same way as the first, the Rigips hybrid wall is ready for filling work.
- The board/ connecting joints and screw heads should be filled with VARIO joint filler.

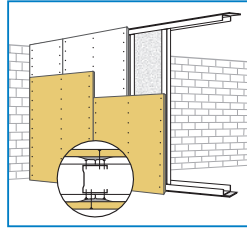
**Material requirements per m² (MW12RFRH)**

Rigips RF 12.5 m fireproof board	2.0 m ²
Rigidur H 12.5	2.0 m ²
RigiProfil MultiTec CW 50	1,800 mm
RigiProfil MultiTec UW 50	800 mm
Rigips 6 x 40 mm nail dowels	1.6 units
One-sided, self-adhesive Rigips felt joint seal, 50 mm	1,200 mm
Mineral wool (any)	1.0 m ²
Rigips TN 3.5 x 25 mm drywall screws	10 units
Rigidur Fix 3.5 x 40 mm drywall screws	20 units
VARIO joint filler	0.78 kg

i Rigips information

Further information on the systems can be found at rigips.de/MW12RFRH or accessed directly via the QR code shown.

**9.8.2 Rigips GK Top hybrid wall****Metal substructure**

- RigiProfil MultiTec UW: UW 50, UW 75, UW 100 for floor / ceiling joints and
- RigiProfil MultiTec CW: for wall joints, fastened with nail dowels at intervals of 1,000 mm.
- Joint seals:
 - All connecting profiles should be fitted with Rigips joint seals.
 - **without** fire protection requirements: Rigips felt joint seal
 - **with** fire protection requirements: Rigips felt joint seals as long as they are protected by filler or Rigips boards in the same thickness as the panelling. Otherwise, A1 joint seals made of mineral wool, building material classification A in accordance with DIN 4102-1 should be used.
- RigiProfil MultiTec CW: CW 50, CW 75, CW 100
- Stud spacing: usually 625 mm
- Rigips LW wall profiles: LW 60 / 60 for corners.

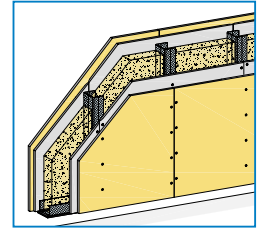
**! Notes**

- Profiles should be cut to size using plate shears, guillotine shears, nibblers or metal circular saws – never use an angle grinder, as the burning will destroy the corrosion protection.
- Position CW stud profiles with the closed side facing in the direction of installation.

Cavity insulation

Mineral wool as panels or rolls (weight and thickness according to requirements).

Panelling of the first wall side - first layer of panelling

- The first layer of panelling (Rigidur H 12.5) should begin with a full width board (1,249 mm). Use a power screwdriver to fasten the Rigips gypsum fibreboards to the stud profiles with Rigidur Fix 30 mm dry-wall screws at intervals of ≤ 250 mm.
- If transverse joints are necessary, they should be positioned so that they are offset by ≥ 500 mm and in the upper third of the wall where possible.
- Joint filling is not necessary (but joint boards).

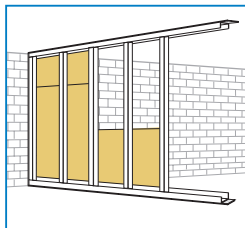

Panelling of the first wall side - second layer of panelling

- The second layer of Rigips boards should be fastened to the Rigidur H gypsum fibreboards independently of the substructure either with three rows of Rigips HartFix 25 mm dry-wall screws – one down each board edge and one down the centre – at intervals ≤ 250 mm or with four rows of 22 mm expansion staples at intervals ≤ 150 mm. All boards should be butt jointed.
- Vertical joints in the second layer of panelling should be offset from those in the first layer by ≥ 200 mm.
- If transverse joints are necessary, they should also be offset by ≥ 500 mm.

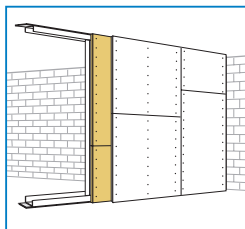

Cavity insulation

- After panelling the first wall side and adding any necessary electrical and sanitary installations in the wall cavity, insulation may be added to improve sound insulation and fire protection. The entire cavity should be insulated.
- Ensure that the insulating material cannot slip out of position.

! Note

To prevent cracking, the joints in the top layer of panelling may only be filled once both wall sides have been closed and no further changes in the length of the boards are expected.
For further information, please refer to the „Joining techniques“ section.

Panelling of the second wall side

- The panelling must be installed with facing joints.
- Once the second wall side has been installed in the same way as the first, the Rigips hybrid wall is ready for filling work.
- Subsequent filling work on board / connecting joints and screw heads with Rigips VARIO joint filler ensures final stability.

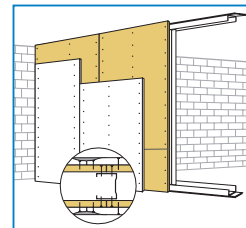

Material requirements per m² (MW12RHRF)

Rigidur H 12.5	2.0 m ²
Rigips RF 12.5 m fireproof board	2.0 m ²
RigiProfil MultiTec CW 50	1,800 mm
RigiProfil MultiTec UW 50	800 mm
Rigips 6 x 40 mm nail dowels	1,6 units
One-sided, self-adhesive Rigips felt joint seal, 75 mm	1,200 mm
Mineral wool (any)	1.0 m ²
Rigidur Fix 3.5 x 30 mm drywall screws	20 units
Rigips HartFix 3.8 x 25 mm drywall screws	20 units
VARIO joint filler	0.72 kg

i Rigips information

Further information on the systems can be found at rigips.de/MW12RHRF or accessed directly via the QR code shown.



9.9 Wall systems: Metal double stud partition walls

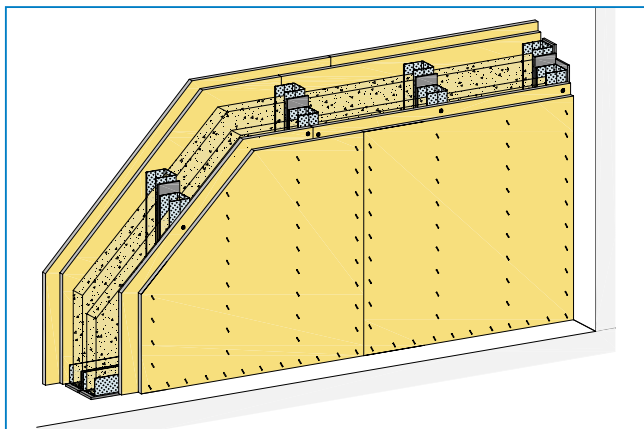

Metal substructure

- Realisation: Rigips generally recommends using double stud partition walls for partition walls in flats. Both substructure rows should be firmly joined along the entire height of the profile using double-sided, self-adhesive felt strips.
 - To fix the spacing, it is recommended that one-sided self-adhesive felt is attached to the sides of the Rigips UW profiles on the ceiling and floor first.
 - The side of the CW studs facing the wall cavity should be fitted with double-sided self-adhesive felt strips. However the side of the strip facing the next profile should be kept covered in the first instance.
 - The next profile should then be held so that it is slightly splayed and then pushed into position, ensuring it is straight and standing firmly on the floor.
 - Expose the adhesive and press the two profiles firmly together.
- RigiProfil MultiTec UW 50/75/100 for the floor/ceiling joints
- RigiProfil MultiTec CW 50/75/100, stud spacing: usually 625 mm
- Rigips LW 60/60 wall profiles for corners
- Attach joint seals to all connecting profiles.

! Note

Profiles should be cut to size using plate shears, guillotine shears, nibblers or metal circular saws – never use an angle grinder, as the burning will destroy the corrosion protection.

Cavity insulation

- The cavity insulation may be freely selected.
- However, where special sound insulation and fire protection requirements exist, the cavity insulation should be selected in accordance with the system overview.

Panelling

- Two layers, depending on requirements: Rigidur 12.5.

Material requirements per m² (MW22RH)

Rigidur H 12.5	4.0 m ²
RigiProfil MultiTec CW	3,600 mm
RigiProfil MultiTec UW	1,600 mm
Rigidur joint adhesive (per joint meter)	15 ml
Mineral wool	2.0 m ²
Rigips nail dowels	3.2 units
Rigidur Fix 3.5 x 30 mm drywall screws	10 units
Rigidur Fix 3.5 x 40 mm drywall screws	20 units
Double-sided, self-adhesive Rigips felt joint seal, 50 mm	2,400 mm
VARIO joint filler	0.52 kg

i Rigips information

Further information on the systems can be found at rigips.de/MW22RH or accessed directly via the QR code shown.



9.10 Wall systems: Metal double stud partition walls as installation walls

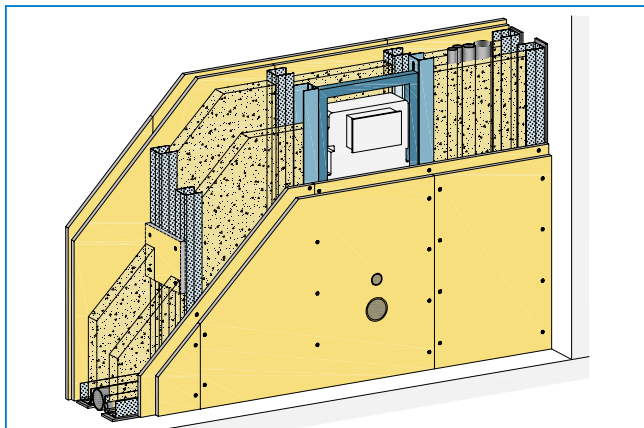

Metal substructure

- Realisation: The cavity in the substructure is determined by the thickness of the required installations.
 - To ensure stability (load absorption), no cuts may be made in the profiles.
 - The parallel CW studs should be joined using board strips (≥ 200 mm height) at the points of the thirds in the wall height or at least every 1,200 mm.
 - To prevent the insulation from slipping out of position in the wall cavity, profile pieces should be fixed to the web sides of the Rigips CW studs using e.g. double-sided adhesive tape.
- RigiProfil MultiTec UW 50/75/100 for floor/ceiling joints
- RigiProfil MultiTec CW 50/75, stud spacing: usually 625 mm for the wall joints
- Attach joint seals to all connecting profiles.

! Note

Profiles should be cut to size using plate shears, guillotine shears, nibblers or metal circular saws – never use an angle grinder, as the burning will destroy the corrosion protection.

Cavity insulation

- The cavity insulation may be freely selected.
- However, where special sound insulation and fire protection requirements exist, the cavity insulation should be selected in accordance with the system overview.

Panelling

- Single- or double-layer panelling. Spacing between studs: usually 625 mm (500 mm for small-format Rigidur boards).
- We recommend two-layer planking for fire protection and sound insulation reasons.

Material requirements per m² (IW22RH)

Rigidur H 12.5	4.0 m ²
RigiProfil MultiTec CW	3,600 mm
RigiProfil MultiTec UW	1,600 mm
Rigidur joint adhesive (per joint meter)	15 ml
Mineral wool	2.0 m ²
Rigips nail dowels	3.2 units
Rigidur Fix 3.5 x 30 mm drywall screws	10 units
Rigidur Fix 3.5 x 40 mm drywall screws	20 units
One-sided, self-adhesive Rigips felt joint seal, 50 mm	2,400 mm
VARIO joint filler	0.52 kg

i Rigips information

Further information on the systems can be found at rigips.de/IW22RH or accessed directly via the QR code shown.



9.11 Installation of sanitary equipment

When installing sanitary equipment in a partition wall, multiple installations can be attached directly to the partition wall to save time and money.

Light loads

- For light loads, e.g. simple wash-basins max. 600 mm wide, the stands can be installed directly into the Rigips UW profile (flush with the front edge). They should then be fastened to the unfinished floor and to the RigiProfil MultiTec CW (studs) at the sides and permanently secured to prevent them from settling. It is important to ensure that the Rigips UW profile for the floor joint will remain flat on the unfinished floor long term.

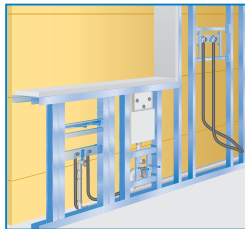

Heavy loads

Sanitary equipment classed as “heavy bracket loads” should be fastened to prefabricated, fully welded or steplessly adjustable Rigips support stands. These stands, which are protected from rust, should be mounted in the wall cavity and will absorb the loads together with the Rigips UA profiles and the panelling. The regulations set out in DIN 18340 must be observed during installation.

- Once the substructure, together with the sanitary equipment stands, and panelling on one wall side are complete, a plumber can install the sanitary equipment.
- Brackets, collars and the fittings on the stands should be used for fastening purposes.
- To absorb the sound of flowing water, the pipe fastenings should be separated from the wall substructure using rubber seals, felts or similar.
- Cold water pipes should be clad to absorb the sound of flowing water and prevent the formation of condensation.

- Stands for wall-mounted toilets and heavy wash basins must be fastened flush with the Rigips UW wall profile and firmly secured to prevent them from settling.
 - Wall-mounted toilets on room-height partitions must be properly supported.
 - A wall-mounted toilet must be connected to the wall in such a way that an additional load of to 400 kg can be transmitted through the substructure into the solid unfinished floor.

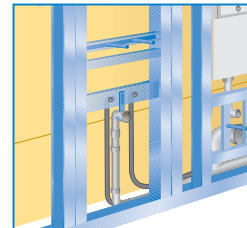

Installation of a stand for a simple wash basin



Processing note

We recommend using mineral wool to insulate installation walls.

Installation outlets

- Installation outlets, e.g. for water pipes, should be cut approx. 10 mm larger than the diameter of the pipe.
- Installation outlets, plus all joints and corners should be sealed with a plasto-elastic, fungicidal sealant.
- If shower outlets are fastened using special installation parts (including sound-insulating rubber seals), no additional measures are necessary.

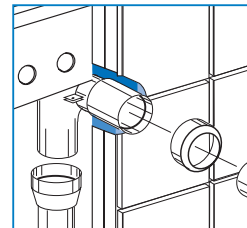

9.12 Wall systems: Wooden single stud partition walls

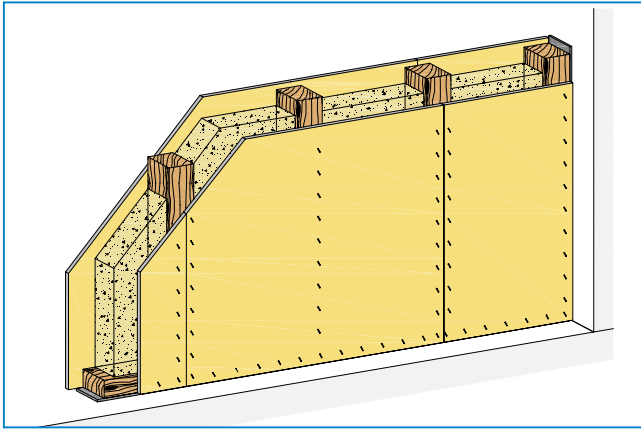

The wooden substructure comprises wood from grading class S10 in accordance with DIN 4074, residual moisture $\leq 20\%$.

Wooden substructure

- Joints:
40 x 60 or 60 x 60 mm timbers as floor and ceiling joints.
- Wooden studs:
40 x 60 / 60 x 60 mm, stud spacing usually 625 mm.
- Joint seals:
All joints should be fitted with Rigips joint seals.

Cavity insulation

- The cavity insulation may be freely selected.
- However, where special sound insulation and fire protection requirements exist, the cavity insulation should be selected in accordance with the system overview.

Panelling

- Single- or double-layer panelling, depending on requirements:
Rigidur 10 or 12.5

Material requirements per m² (HW11RH)¹⁾

Rigidur H 10 / 12.5	2.0 m ²
Wooden studs e.g. = 60 x 100 mm	1,800 mm
Timbers for threshold and top plate, e.g. = 60 x 100 mm	800 mm
Rigips frame and lath anchors 8 x 100 mm	1.6 units
Cavity insulation (if necessary)	1.0 m ²
One-sided, self-adhesive Rigips felt joint seal, 50 mm	1,200 mm
Rigidur Fix 3.5 x 30 mm drywall screws	20 units
VARIO joint filler	0.4 kg

¹⁾ Values for single-layer panelling

Rigips information

Further information on the systems can be found at rigips.de/HW11RH or accessed directly via the QR code shown.



9.13 Wooden substructure / installation process

Marking

- Mark the position of the wall on the floor.
- Include door openings.
- Also mark the wall position on the ceiling.

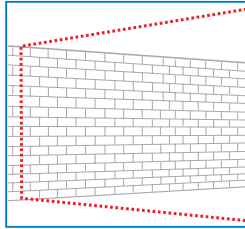

Joints

- Rigips felt joint seal with adhesive on one side is attached to the connecting timbers, which are fastened to the floor and ceiling with frame anchors at intervals of 1,000 mm.
- The wooden stud framework on the flanking components must be joined tightly to the Rigips felt joint seal for sound protection reasons

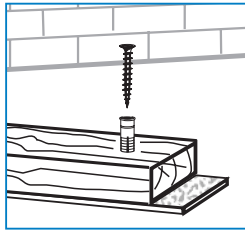

Wooden studs

- Depending on wall height requirements, 40 x 60 mm or 60 x 60 mm timbers should be installed as the substructure.
- The centre-to-centre distance between the wooden studs should be 500 mm for small-format Rigidur boards and ≤ 625 mm for large-format Rigidur boards.
- The wooden studs should be fixed to the connecting timbers using appropriate nails or screws.

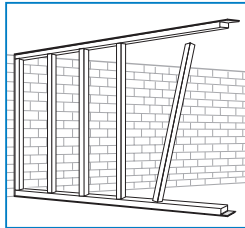

! Note

Floor/ceiling joints should be realised in the same way as described on page 79.

Panelling of the first wall side

- When installing one layer of panelling, the Rigidur gypsum fibreboards should be installed with facing joints. If transverse joints are necessary, they should be positioned so that they are offset by ≥ 400 mm.
- When installing two layers of panelling, the lower layer may be butt jointed (see also the „Joining techniques“ section).

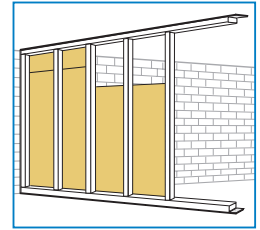

! Note

Follow the information provided in the „Joining techniques“ section for the appropriate type of joint selected.

Cavity insulation

- After panelling the first wall side and adding any necessary electrical and sanitary installations in the wall cavity, insulation should be added to improve sound insulation and fire protection.
- The entire cavity should be insulated. Ensure that the insulating material cannot slip out of position.

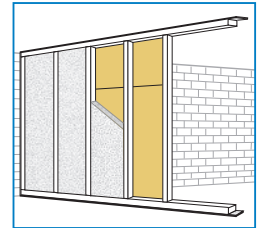

! Processing notes

- Notches may be cut into the upper part of wooden studs. Solely round drill-holes should be cut into wooden studs for large cable openings. A cross-section of at least 15 mm on both sides must be retained.
- Information on installing electrical sockets, etc. can be found on pages 81 - 85.

Panelling of the second wall side

- The panelling must be installed with facing joints.
- Subsequent filling work on board/ connecting joints and screw heads ensures final stability.

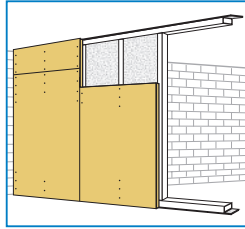
**Note**

Component separation joints in the building shell should be continued in Rigips panelled walls. Otherwise, expansion joints should be included at least every 10 m.

9.14 Wall systems: Wooden double stud partition walls**Wooden substructure**

- Joints: wood $w \times t \geq 60 \times 80$ mm for floor and ceiling joints fastened using frame anchors.
- Joint seals: All connecting profiles should be fitted with Rigips joint seals.
 - **without** fire protection requirements: Rigips felt joint seals.
 - **with** fire protection requirements: Rigips felt joint seals as long as they are protected by filler or panelling (otherwise Rigips A1 joint seals).
- Wooden stud profiles: wood $w \times t \geq 60 \times 80$ mm
- Stud spacing: usually 625 mm.

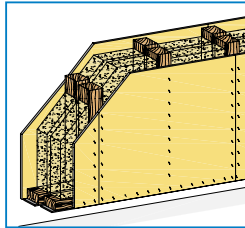
**Cavity insulation**

- Mineral wool as panels or rolls (weight and thickness according to requirements, see system descriptions); ensure that it cannot slip out of position.

Panelling

- Single-, double- or triple-layer panelling, depending on requirements: Rigidur 10 or 12.5.

Material requirements per m² (HW21RH)¹⁾

Rigidur H 12.5	2.0 m ²
Wooden studs e.g. $w \times t \geq 60 \times 80$ mm	3,600 mm
Wooden $w \times t \geq 60 \times 80$ mm for threshold and top plate	1,600 mm
Rigips nail dowels 6 x 40 mm	3.2 units
One-sided, self-adhesive Rigips felt joint seal, 50 mm	2,400 mm
Mineral wool (if necessary)	1.0/2.0 m ²
Rigidur Fix 3.5 x 30 mm drywall screws	20 units
VARIO joint filler	0.4 kg

¹⁾ Values for single-layer panelling

i Rigips information

Further information on the systems can be found at rigips.de/HW21RH or accessed directly via the QR code shown.



Chapter contents

10.1	Installation of door openings	110
10.2	Installation of door frames	116

10.1 Installation of door openings

If door openings are planned in Rigips partition walls, the loads (door leaves) from them must be absorbed accordingly.

! Note

In order to prevent unforeseeable loads, we generally recommend the use of Rigips bracing profiles UA!

- The Rigips UA bracing profiles should be cut shorter to allow for the expected bending of the ceiling under load.
- The UA profiles are fastened directly to the floor and ceiling. The Rigips door jamb plug-in angle sets are used for this. The lintel is formed horizontally with a Rigips lintel profile. The pre-punching determines the respective construction opening dimension. This is matched to common standard door frame widths. The door lintel profile is cut to fit at the pre-punching, bent over and fastened to the Rigips UA stiffening profiles with suitable sheet metal screws. A RigiProfil MultiTec UW can be installed as an alternative.
- Longitudinal and any unavoidable transverse joints should be positioned at least 150 mm from the door opening.
- The planking is fastened in the UA profiles using TB drywall screws with a drill point.
- For heavy door constructions, the frames are fixed to Rigips stiffening profiles UA with a thickness of 2 mm.

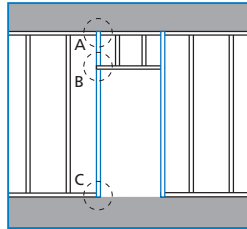

Door opening with Rigips UA bracing profiles

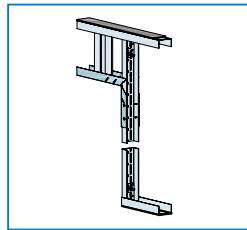

Mounting of the Rigips connecting bracket installation set

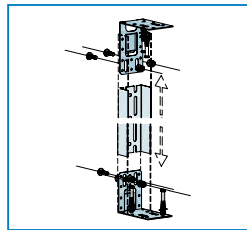

Rigips door jamb plug-in angle set

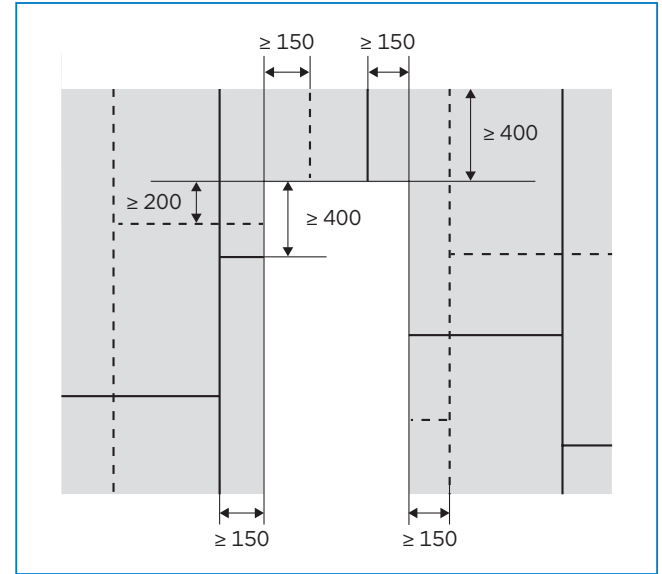

Longitudinal and any unavoidable transverse joints should be positioned at least 150 mm from the door opening

Examples for wall openings

- **Variant 1** shows a wall opening with max. 2 replacements. The reveal profiles can be made with CW profiles. A UW profile can be used as a lintel profile.
- **Variant 2** shows a wall opening with max. 3 replacements. The reveal profiles must be made with UA profiles. A UW profile can be used as lintel profile. The connection areas must be fixed with connection angles with a minimum thickness of 2 mm.
- **Variant 3** shows a wall opening with max. 4 replacements. In this variant, the reveal profiles and lintel profiles must be made with UA profiles. The connection areas must be fixed with connection angles with a minimum thickness of 2 mm.

! Note

The following illustrations show the possibilities of different design variants for wall openings. Further specifications of the manufacturers of installation parts must be observed.

Example variant 1: Wall opening with max. 2 replacements

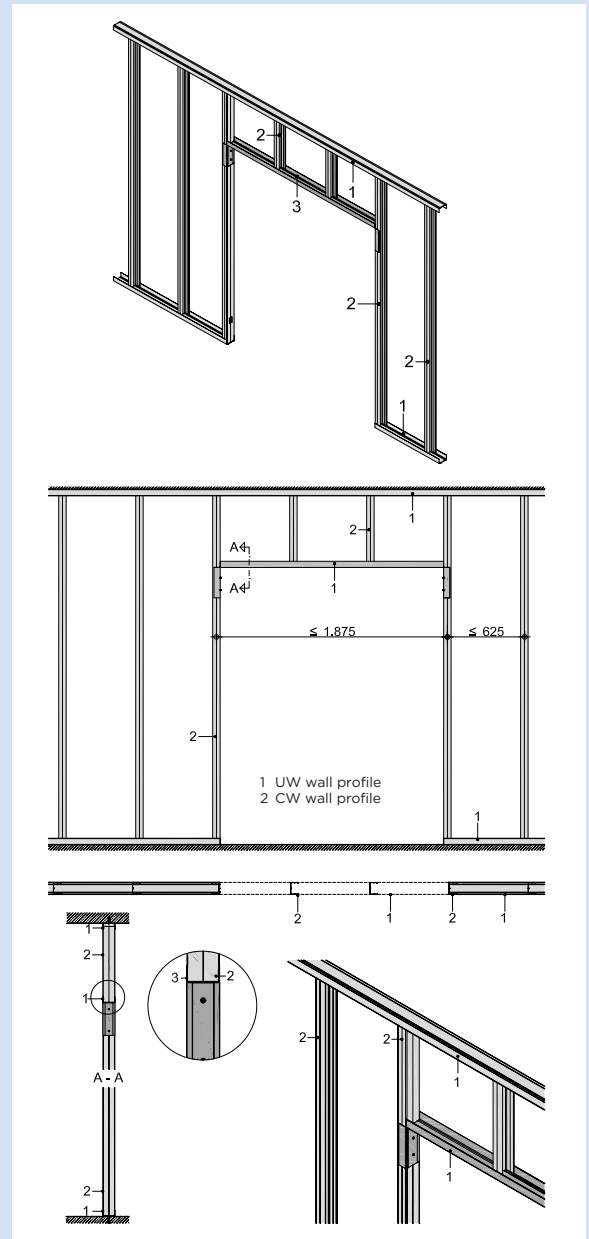

**Example variant 2:
Wall opening with max. 3 replacements**

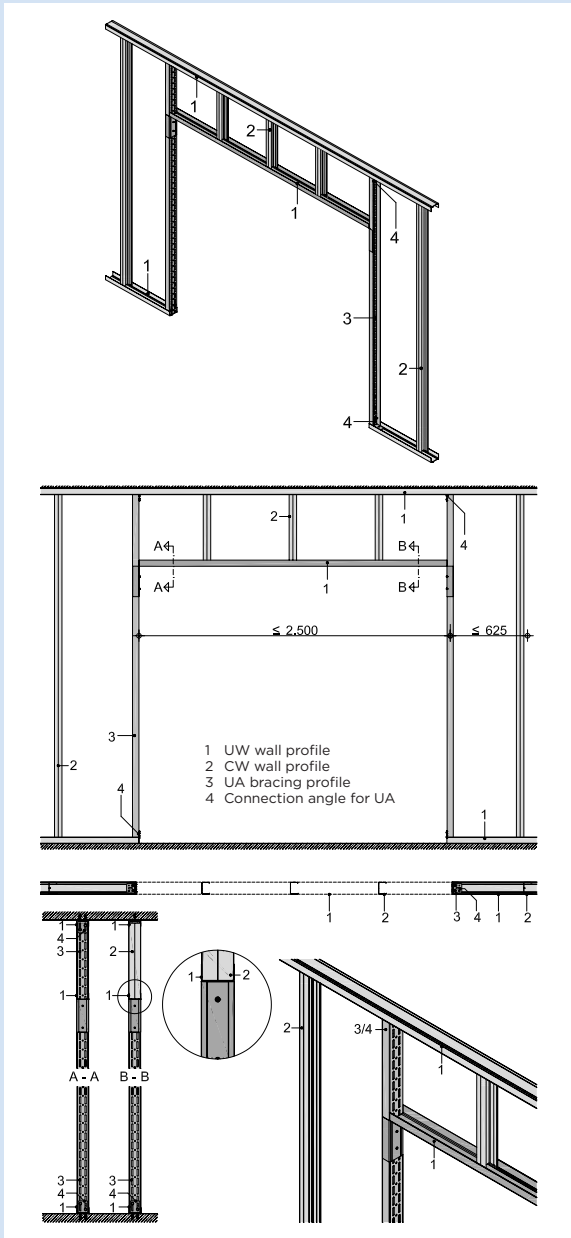

**Example variant 3:
Wall opening with max. 4 replacements**

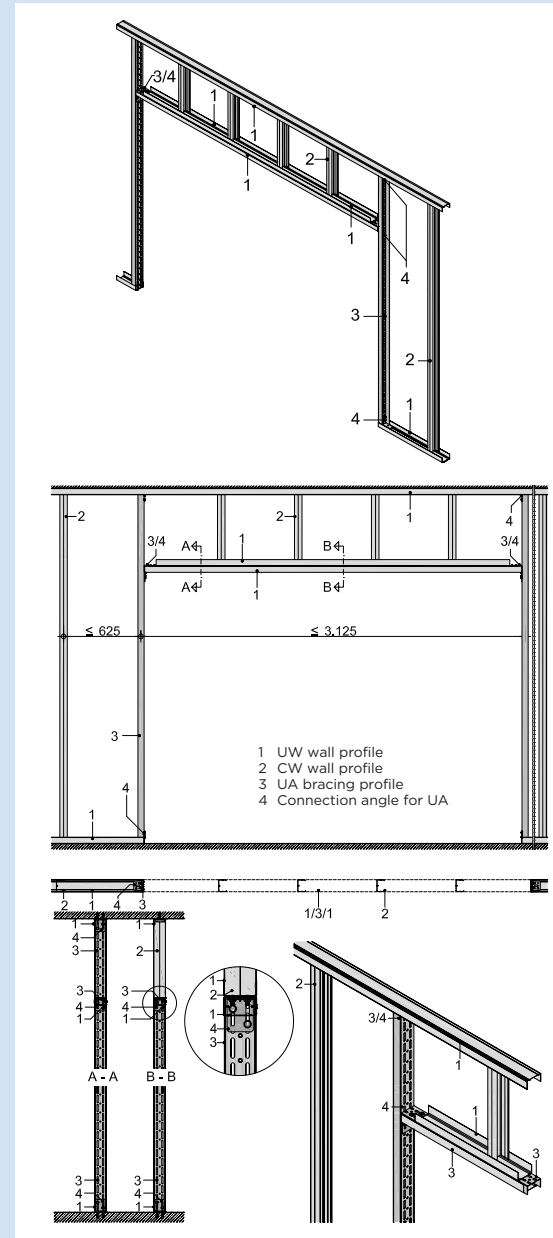

! Notes

- Rigips CW wall profiles with wooden studs cannot replace Rigips UA bracing profile.
- For a wall height of max. 260 cm, a door width of 88.5 cm and a door leaf weight of max. 25 kg, door frames can be attached to normal RigiProfil MultiTec CW (sheet thickness 0.6 mm).

10.2 Installation of door frames

- One-piece frames should be installed before the panelling.
- Multi-piece door frames should be inserted once the panelled wall and the door opening are complete.
- The cavity between the profile and frame should be filled with insulation. If fire doors are to be installed, mortaring may be necessary. Check whether the door has the appropriate approval.

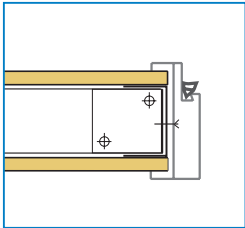

Installation of a steel frame:
example with Rigips UA bracing
profiles (insulation not shown)

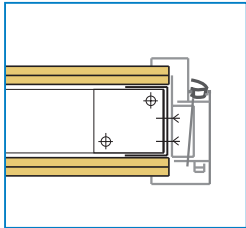

Installation of a multi-piece
door frame: example with
Rigips UA bracing profiles
(insulation not shown)

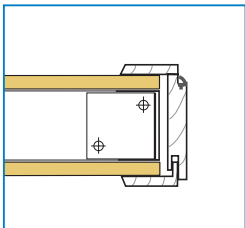

Installation of a wooden frame:
example with Rigips UA
bracing profiles and wooden
studs (insulation not shown)

! Note

The frame and insulation must be installed in accordance with requirements (as quoted) and the frame manufacturer's installation instructions must be observed.

🏗️ Processing notes

Door and window openings have a negative impact on the sound insulation of a partition wall. The sound insulation requirements set out in DIN 4109 generally apply to installed doors (door leaf plus frame). The level of sound insulation is dependent on the sound insulation of the door leaf and the quality of the rebate seals, in particular the sealing on the lower door joint. Door and window manufacturers must have sound insulation certification.

Weight of the door leaves

Door jamb profiles depending on the width and weight of the door leaves

Width of door opening mm	UA 50 kg	UA 75 kg	UA 100 kg	UA 125 kg	UA 150 kg
≤ 1,010	≤ 50	≤ 75	≤ 100	≤ 125	≤ 150
≤ 1,260	≤ 40	≤ 60	≤ 80	≤ 100	≤ 120
≤ 1,510	≤ 35	≤ 50	≤ 65	≤ 80	≤ 95

Note: These tables indicate the installation recommended by Saint-Gobain Rigips GmbH. When installing other door dimensions, weights or additional requirements, separate structural verification (e.g. structural analysis) must be realized as the installation of square or rectangular steel tubes may be necessary.

Chapter contents

11.1	Attic panelling	120
11.2	Insulation/ vapour barrier	122
11.3	Fixed joints/ details	122
11.4	Jamb walls	124

11.1 Attic panelling

The same requirements generally apply for panelling material for ceilings and sloped roofs as for walls. Specifically this includes heat / sound insulation and fire protection. For heating reasons, it is expedient to insulate and panel the entire sloped roof area. To meet damp protection requirements (risk of moisture penetration as a result of condensation) a vapour barrier film should also be installed up to the apex in addition to the insulation and panelling.

Substructure

- Comprises: Steel sheet profiles galvanized in accordance with DIN 18182 or wooden laths, grading class S 10 in accordance with DIN 4074, part 1, residual moisture $\leq 20\%$.

! Notes

Correct system installation:

- Collar beam roofs and sloped roofs should be fully insulated and sealed so that they are wind-proof.
- The metal / wooden substructure should be screwed onto the rafters / beams at right angles.

Metal substructure

- Directly fastened Rigips hat channel profiles.
- Board span (with fire protection): ≤ 375 mm.
- Supporting profiles (with fire protection): ≤ 900 mm.

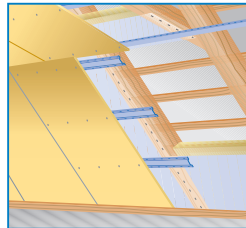

! Note

Profiles should be cut to size using plate shears, guillotine shears, nibblers or metal circular saws – never use an angle grinder, as the burning will destroy the corrosion protection.

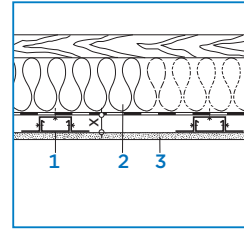

- Rigips direct hangers
- Mineral wool where fire protection requirements exist (mineral wool B1 $d \geq 100$ mm)
- Panelling with Rigidur 10 / 12.5 mm gypsum fibreboards

! Note

Rigips CD 60 / 27-06 ceiling profiles may be attached using Rigips "Klick Fix" direct hangers.

Wooden substructure

- 50 / 30 mm or 48 / 24 mm supporting laths.
- Board span (with fire protection): ≤ 375 mm.
- Supporting laths (with fire protection): ≤ 900 mm.

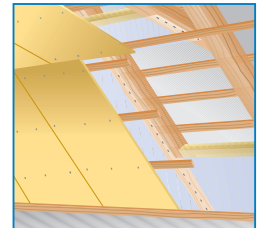

Panelling

- Rigidur 10 / 12.5 mm gypsum fibreboards
- Fastening: Rigidur Fix 3.5 x 30 mm drywall screws or expansion staples (see also the „Fasteners“ section).

! Notes

The following panelling installation order should be observed:

- 1st step: Panelling of the ceiling / collar beam area
- 2nd step: Panelling of the sloped roof section
- 3rd step: Creation of jamb walls

11.2 Insulation/vapour barrier

- To prevent excessive vapour diffusion, a vapour barrier should be installed on the heated side between the panelling and heat insulation.
- The insulating material width should be selected to ensure that the insulating mats can be jammed between the wooden beams, i.e. it should be approx. 10 mm wider than the gap between the beams.
- It is particularly important to ensure that the vapour barrier is fastened to the beams and adjoining gable walls so that it is air-tight. The manufacturer's instructions must be observed precisely. Edges, joints and cracks should be sealed using e.g. suitable adhesive tape.

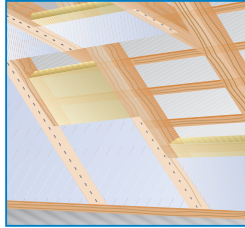

! Notes

- The vapour barrier layer usually also ensures that the structure is air-tight. It is particularly important in this respect that the joints to the walls and any penetrations are permanently and tightly sealed.
- Please refer to the insulation manufacturer's processing instructions for more details.

11.3 Fixed joints/details

- To ensure a clean fit between the ceiling and roof surfaces, the board edges should be bevelled to match the roof angle.
- Where two surfaces such as the ceiling and sloped area of the roof or the sloped area of the roof and jamb wall meet or where surfaces adjoin gable walls, etc., separator strips such as Rigips TrennFix should be inserted between the two layers of panelling (adhesive tapes used for vapour barriers are not suitable). The joints are then filled on top of these separator strips

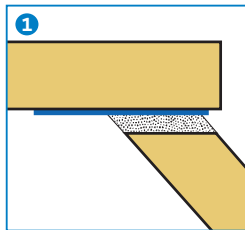

Filling with VARIO joint filler
(joint gap: 5 mm)

enabling proper separation of the surfaces and the creation of a hairline joint. **1.**

- Joints to sloped and collar beam roofs may also be realized using Rigips AquaBead Flex PRO. This flexible edge protection is bonded on and then covered with VARIO joint filler **2.**
- Alternatively, Rigips Levelline may be used. VARIO joint filler should be used to fill the joint areas and then spread broadly over the entire corner area. Lay the Rigips Levelline in the filler, push both sides onto the corner and firmly press them down using the Rigips one-sided roller. Then remove excess filler and the installation of the Rigips Levelline is complete.
- Sealing of the corner is only advised where there are sufficiently wide joints in the panelling and the plasto-elastic joint compounds can only adhere on two sides. It should also be noted that such joints should be renewed every few years.

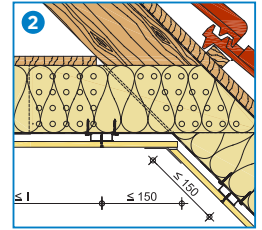

Joint between the sloped area of the roof and the collar beam ceiling with Rigips AquaBead Flex PRO

Processing notes

- When filling corners with reinforcement strips, there is a risk that the corner will become rounded.
- Internal corners in attics can be realized easily using the flexible Rigips AquaBead Flex PRO for all angles or Rigips Levelline.



Rigips AquaBead Flex PRO



Rigips Levelline

11.4 Jamb walls

Metal substructure

- Rigips UW 50 wall profiles for floor and ceiling joints and
- Rigips CW wall profiles for the wall joints.
- Joint seals: Connecting profiles should be fitted with Rigips joint seals (except for those on sloped roof areas).
 - **Without** fire protection requirements: Rigips felt joint seals.
 - **With** fire protection requirements: Rigips felt joint seals as long as they are protected by filler or panelling. Otherwise Rigips A1 joint seals.
- Rigips wall profiles: CW 50, stud spacing: 500 mm or \leq 625 mm.

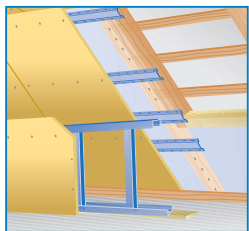

Cavity insulation

- Mineral wool as for sloped roofs (weight and thickness according to requirements, see roof description).

Panelling

- With and without fire protection requirements: Rigidur 10/12.5 mm.

Installation

- The jamb wall should only be installed once the entire ceiling surface is finished.
- To fasten the metal studs at the top, a Rigips UW wall profile should be attached to the panelling on the sloped area of the roof using appropriate fasteners which should be connected to the substructure of the sloped area of the roof.
- The Rigips CW wall profiles should be inserted into the upper and lower Rigips UW wall profiles.
- A joint seal – as for partition walls – should be inserted below the Rigips UW wall profile (floor joint).

Wooden substructure

- Joints: 40 x 60 mm timbers as a base for the joint to the floor, fastening to the solid wall with Rigidur drywall screws, wood screws or frame dowels and to the roof joint with Rigidur Fix drywall screws or wood screws.
- Joint seals: Joints should be fitted with Rigips joint seals (except for those on sloped roof areas).
 - **Without** fire protection requirements: Rigips felt joint seals.
 - **With** fire protection requirements: Rigips felt joint seals as long as they are protected by filler or panelling, otherwise Rigips A1 joint seals.
- Wooden studs: 40 x 60 mm, stud spacing: 500 mm or 625 mm.

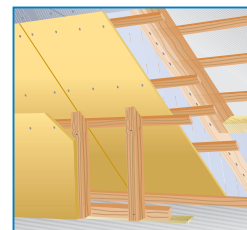

Cavity insulation

- Mineral wool as for sloped roofs (weight and thickness depending on requirements, see roof description).

Panelling

- With and without fire protection requirements: Rigidur 10/12.5 mm.

Montage

- The jamb wall should only be installed once the entire ceiling surface is finished.
- A lath should be screwed into the panelling and substructure on the sloped area of the roof to fasten the top of the wooden studs into place.
- The wooden studs should generally be bevelled to match the roof angle and fastened to the top and bottom joint timbers using screws or nails.
- A joint seal should be fitted under the beam.

Chapter contents

12.1	Fitted ceilings	128
12.2	Ceiling panelling	128
12.3	Hanger systems	129
12.4	Joints	134
12.5	Installing Rigidur ceilings	135
12.6	Suspended fitted ceilings	137
12.7	Directly fastened fitted ceilings	138

12.1 Fitted ceilings

Fitted ceilings are suspended from the slab using approved hanger systems.

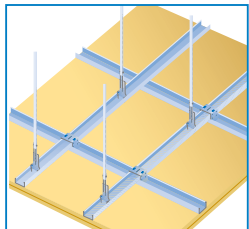

12.2 Ceiling panelling

Ceiling panelling comprises a sub-structure made of wooden laths, Rigips CD ceiling profiles or Rigips hat channel profiles attached directly to the slab. The substructure is anchored to the slab by means of building code approved screws or dowels.

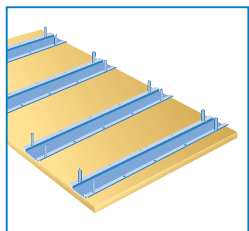

Dowels or screws

- Dowels must be building code approved for use as anchors for fitted ceilings and the individual substrate in accordance with DIN 18168.
- With wooden substrates, the screws should be inserted into the load-bearing substrate sideways or from below (fastening to the formwork is not sufficient). They should be large enough to transmit the occurring loads safely into the substrate. The length of the screws should be oriented to the thickness of the hanger to be fastened into place plus the required penetration depth into the substrate.

! Note

The appropriate fasteners for attaching Rigidur H gypsum fibreboards to substructures can be found in the „Fasteners and spacing“ section starting on page 43.

12.3 Hanger systems

Rigips® fast hangers

- Approved hangers include Rigips wires with eyelets or Rigips hooked wires with tensioning springs and Rigips fast hangers which form part of the substructure (laths or Rigips CD 60 / 27 ceiling profiles), e.g. anchor quick hangers. Suspended ceilings subject to tensile loading can be created with Rigips fast hangers.
- The permitted loads per hanger range from 0.15 to 0.25 kN.
- The Rigips hanger wire (in accordance with DIN 18168) must extend through the spring of the lower section by at least 10 mm.



Anchor quick hanger

! Note

Rigips nonius systems should be used for greater loads / ceiling weights due e.g. to thicker panelling.

Rigips® nonius hanger systems

- Rigips nonius hanger systems should also always be selected where it is necessary that the hangers remain rigid under pressure.
- Rigips nonius hanger systems can bear loads of up to 0.40 kN.
- The joint between the adjusting pin and the corresponding lower section for the substructure should generally comprise two locking elements.
- Hangers must always be positioned vertically and so that they connect the substructure directly to the slab without any clearance.

**Note**

If the hangers are not positioned vertically or subject to tensile loading, there is a risk of overloading and thus failure of the directly adjacent hangers. Under certain circumstances, hangers not subject to tensile loading may also cause ceiling surfaces to rattle when there are movements in the air (draughts, etc.).

Substructures

Substructures may be created from wooden laths with a max. moisture content of 20% or Rigips CD 60/27 ceiling profiles in accordance with DIN 18182-1. For fitted ceilings, they generally comprise base and supporting laths or profiles. The cross sections of the wooden laths must correspond to the specifications set out in the table below.

Wooden lath dimensions

Base laths mm		Supporting laths mm
50/30	with	60/40 or 50/30
60/40	with	60/40 or 50/30

- The base and supporting laths can be joined using one Rigips drywall screw/ wood screw or two nails inserted at an angle at each crossing point. Profiled nails classified in load bearing class 2 or 3 in accordance with DIN EN 14592 should be used. In accordance with DIN EN 1995-1-1, they should be large enough to transmit the occurring loads safely.
- In CD profile structures, the profiles should be joined using Rigips anchor brackets or Rigips crossover fast connectors.
- In level substructures, Rigips CD ceiling profiles should be held together using Rigips safety transverse connectors.
- The centre-to-centre distances in the substructure should be oriented to the Rigips ceiling system used. Details can be found in the table below.
- Ceiling panelling may also be installed on a simple substructure solely comprising supporting laths and profiles.

Note

Fireproof ceilings should be realised in accordance with the information on the corresponding ceiling systems provided in "Planen und Bauen" (German only) and the relevant test certificates (Rigips system SD11RH).

Distances between supports for substructures

Panelling thicknesses ≥ 10 mm
(without fire protection requirements)

Distances ¹⁾ between supports for loads in kg/m² up to

15 30 50

Metal substructure

	15	30	50
Base profile CD 60	900	750	600
Support profile	1.000	1.000	750
Hat channel profile	1.000	1.000	750

Wooden substructure

	15	30	50
Base lath 48/24 directly fastened	750	650	600
Base lath 50/30 directly fastened	850	750	600
Base lath 60/40 directly fastened	1.000	850	700
Base lath 30/50 suspended fitted	1.000	850	700
Base lath 60/40 suspended fitted	1.200	1.000	850
Supporting lath 48 / 24	700	600	500
Supporting lath 50 / 30	850	750	600

¹⁾ For base profiles or base laths, the support span is the distance between the suspensions. For support profiles or support battens, the support span is the centre distance of the base profiles or base laths.

Panelling

Rigidur ceilings should generally be panelled at right angles to the supporting structure and with transverse joints separated by at least one supporting lath.

**Processing note**

Cross and floating joints are not permitted.

- In multi-layer panelling, the longitudinal joints in the individual layers should be offset by at least 400 mm. The transverse joints of the upper and lower panelling layers must also be separated by at least one supporting lath.
- The permitted Rigidur board spans for standard systems are set out in the following table.

Permitted Rigidur® board span for ceiling panelling and fitted ceilings

Board type / thickness mm	Span mm
Rigidur 10	400
Rigidur 12.5	500

! Note

A mineral wool layer should be inserted in the space above the suspended ceiling where necessary. Check the relevant test certificates where fire protection requirements exist.

12.4 Joints

The edge joints of fitted ceilings or ceiling panelling can generally be realised in two different ways: as "fixed" or "floating" joints.

! Note

Information about „fixed joints“ can be found in the „Attic conversion“ section on page 118.

Floating joints

Floating joints are edge joints where there is no direct connection between the ceiling structure and adjoining components. These joints are open or concealed shadow gaps or joints at visible edge angles.

Floating joints are used where significant bending of the ceiling under load, major changes in length due to high fluctuations in atmospheric humidity or different component movements are expected.

12.5 Installing Rigidur® ceilings

- Mark the ceiling height on the adjoining components using an alignment line or laser.
- The Rigips hangers should be fastened to the slab at the required intervals.
- When installing the base and /or supporting laths / profiles, it is important to ensure that any joints are separated by at least one hanger.
- The first / last supporting profile on the ceiling should be positioned approx. 150 mm from the adjoining wall.
- Cut Rigips profiles to size (using plate shears, guillotine shears or nibblers).

Processing note

The alignment line or colour mark should mark the lower edge of the substructure and not the panelling as the mark could show through subsequent coatings.

Expansion joints

- Expansion joints in fitted ceilings should be included at least every 8 meters and near expansion joints in the slab. They should also be included in any narrowing areas such as corridors.
- The joint width is dependent on the amount of component movement expected. These movements may be caused by the ceiling bending under load or changes in temperature and moisture levels.

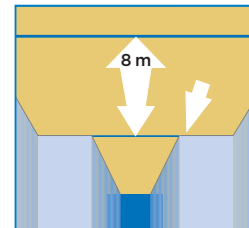

Expansion joints should be included at least every 8 m

Adding installations to fitted ceilings

- Frames must be created in the sub-structure to accommodate openings in the surface of the ceiling for installations such as lights or ventilation vents which are larger than the gaps between profiles.
- This generally also applies for installations weighing ≥ 6 kg.
- The loads of the installations should be transferred to the slab using at least two additional Rigips hangers per frame. The number and type of Rigips hangers is also dependent on the load class and the additional load of the installations which needs to be absorbed.
- Heavy loads which exceed the additional load capacity of dowels and ceiling structures must be fastened directly to the slab or an auxiliary structure which ensures that the load is transmitted into the slab.

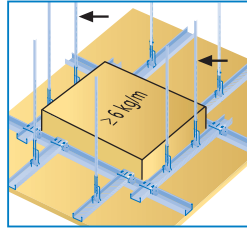

Frame for additional installations

12.6 Suspended fitted ceilings**Ceiling profiles**

Rigips CD 60/27 ceiling profiles (alternatively: with wooden laths) as base and supporting profiles together with hanger systems:

- Rigips anchor quick anchors,
- Rigips anchor hangers for slotted strip hangers or
- Rigips nonius hangers, depending on the weight of the ceiling

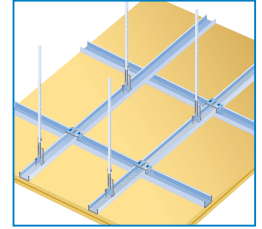
**Profile connectors**

- Rigips crossover fast connectors (for heavy structures)
- Rigips anchor brackets
- Rigips safety transverse connectors or Rigips transverse connectors

Mineral wool layer

- In the space above the suspended ceiling where necessary.
- Check the test certificates where fire protection requirements exist.

Panelling

- Single- or double-layer panelling, depending on requirements: Rigidur 10 or 12.5 mm boards.

12.7 Directly fastened fitted ceilings

Metal substructure

Rigips CD 60 / 27 ceiling profiles together with

- Rigips direct fasteners (running rails).
- Rigips U direct hangers, Rigips "Klick Fix" direct fasteners with or without sound insulation.
- Rigips hat channel profiles and spring strips.

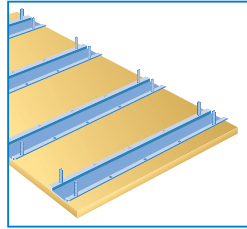

Mineral wool layer

- In the space above the suspended ceiling where necessary.

Panelling

- Single- or double-layer panelling, depending on requirements: Rigidur 10 or 12.5 mm boards.

Wooden substructure

- 50 / 30 mm or 60 / 40 mm supporting and base laths together with
- Spring clips (without additional loads) or
- Rigips U direct hangers.

Mineral wool layer

- In the space above the suspended ceiling where necessary.

Panelling

- Single- or double-layer panelling, depending on requirements: Rigidur 10 or 12.5 mm boards.

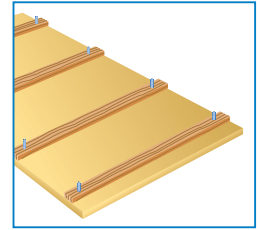

Processing note

Self-supporting fireproof ceilings should be realised in accordance with the information on the corresponding ceiling system provided in "Planen und Bauen" (German only) and the relevant test certificate.

Chapter contents

13.1	Substrates	142
13.2	Priming	142
13.3	Painting	143
13.4	Wallpaper	144
13.5	Tiles	144
13.6	Plaster	145

13.1 Substrates

The person responsible for the final coating of the substrate is responsible for inspection of the substrate and the use of suitable materials.

Pre-treatment

- Mortar splashes, filler burrs and similar must be removed from the board surface.
- All board surfaces, joints and filled sections must be dry and free of dust. Depending on the requirements of the subsequent coating, joints must be levelled off.
- In the case of final coatings that place special requirements on the substrate properties it is recommended that the surface is completely covered with filler.



13.2 Priming

- Rigidur gypsum fibreboards are supplied as water-repellent. Priming is only necessary if a manufacturer specifies it for products included in his system or greater security is required in this regard due to the further processing planned (e.g. thin or textured plasters, paint coatings or tiles).



i Rigips recommendation

For even absorption across the board and filler surfaces, Rikombi primer should be applied in accordance with the processing instructions on the container. The primer must be completely dry before processing continues.

13.3 Painting

- All standard paints, e.g. distemper, emulsion paints and varnishes, oil-based, alkyd resin, polymer resin, polyurethane and epoxy resin paints are suitable.
- Silicone paint may only be applied with a suitable primer.
- For paintwork a double layer of panelling and the use of Rigidur fabric tape (see the section on thin plaster) is necessary.
- Dispersion-modified silicate paints (organo-silicate and dispersion-modified silicate paints) may only be used if the manufacturer expressly guarantees their suitability and provides precise processing instructions. Where these paints have to meet specific requirements in terms of performance characteristics (e.g. washability in accordance with DIN EN ISO 11998), these requirements must be expressly guaranteed.
- A sample paint coat should be applied across several boards including the joints.
- Mineral-based paints such as whitewash, silicate paints and nitro-combi paints are not suitable.
- In each individual case, the paint manufacturer's declaration regarding the suitability of their products for use with gypsum-based materials takes precedence.
- A blocking primer should be used for textured thin plasters and paint coatings to reliably exclude any possibility of colour seepage (yellowing).



13.4 Wallpaper

- All types of wallpaper can be applied using standard wallpaper paste. The manufacturer's instructions must be observed.
- Only adhesives based on methyl-cellulose and/or suitable synthetic resins should be used. It is recommended that the adhesive and surface coating are checked for suitability.
- A double layer of panelling should be used where heavy coatings, e.g. metal wallpapers, are to be applied.

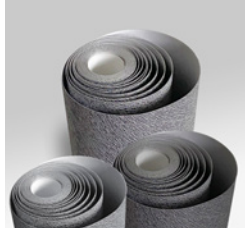

13.5 Tiles

Rigidur H boards are suitable for use in domestic bathrooms.

- Tile weights of up to 25 kg/m² have not proven critical in practice on tileable partition walls (one layer of 12.5 mm panelling) or fixed wall facings. If ceramic coverings are to be applied to free-standing / attached wall facings or drylining, it is recommended that the tile weight is limited to 15 kg/m². With a double layer of panelling comprising Rigidur H 12.5 or thicker, tile weights up to 50 kg/m² have not proven critical in practice. To prevent impermissible wall bending, the stud spacing should be halved or UA profiles used.
- Flexible thin-bed adhesives are suitable for such applications and should be applied using a notched trowel. Flexible joint mortars should be used for joints.

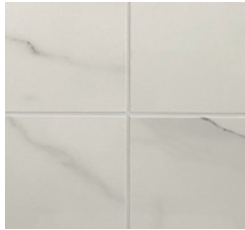

Ceramic tiles (DIN EN 14411), earthenware and glass mosaic tiles can easily be applied to Rigidur gypsum fibreboards. If the manufacturer specifies priming, it should be carried out in accordance with their processing instructions. Allow sufficient time for the primer to dry.

- A flexible surface seal or a thin sealing layer of tile adhesive should be applied to walls that may become wet.
- Flexible thin-bed adhesives are suitable for such applications and should be applied using a notched trowel. A high-grade, cement-based elastic joint material should be used for joints.
- It must be ensured that surface seals in showers and bathtubs are of a sufficient size. Corners and items penetrating wall surfaces should be sealed appropriately using sealing strips, sealing cuffs or similar.
- To insulate against structure-borne sound, a felt strip should be inserted between the bathtub and panelling.
- Products suitable for use with gypsum fibreboards must be used for bonding and joints. In each individual case the trade and manufacturer's guidelines must be observed.
- Tile adhesive should not be used for panelling joints.

13.6 Plaster

- Mineral- or plastic-based textured thin-wall plasters suitable for plasterboards can easily be applied to the Rigidur gypsum fibreboards following application of a blocking primer in accordance with the manufacturer's instructions.
- Large-area fillers should be applied directly to the board surface without prior priming.
- For all Rigidur edge types Rigidur fabric tape should be applied to the joints when coatings involving thin plasters (including loam rendering) or silica-based paints are used. It is only possible to dispense with the use of fabric tape where Rigidur H tapered-edge boards are installed in combination with paper reinforcement strips. At 70 mm wide the white Rigidur fabric tape is ideal for preventing cracks in subsequent coatings. As a fleece fabric it is extremely thin so it does not extend beyond the joint area and offers very high stability. It is applied to Q1-finished joints using Rigips VARIO joint filler or Rigips ProMix Finish. Alternatively, it can be applied to Q1-finished joints – primed with Rikombi primer – using Rigidur Nature Line joint adhesive.



Chapter contents

14.1	Loads on walls	148
14.2	Loads on ceilings	151

14.1 Loads on walls

Various loads can be attached securely to Rigidur gypsum fibreboard wall structures with suitable fasteners. Light items can be fastened using simple picture hooks. Depending on the specific type used, fasteners can hold a wide variety of typical household vertical loads.

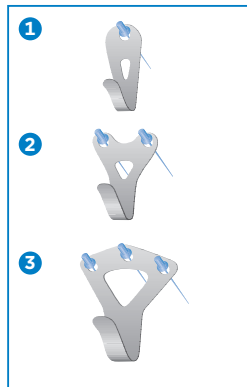

Permitted vertical loads on wall hooks¹⁾

	Panelling		
	Rigidur H 10 mm	Rigidur H 12.5 mm	Rigidur H 2 x 12.5 mm
Hook 1	10 kg	17 kg	20 kg
Hook 2	20 kg	27 kg	30 kg
Hook 3	30 kg	37 kg	40 kg

¹⁾Maximum loads depend on the type and quality of the wall hooks

Permitted loads on cavity dowels and fully threaded screws

Shelves and hanging cupboards can easily be attached using fully threaded screws (so-called chipboard screws) or cavity dowels. The maximum permitted load for the wall structure must be observed. Bracket loads can be fastened anywhere on Rigidur gypsum fibreboard panelling using standard fasteners. The selection of suitable fasteners is dependent on the load depth t (for walls) and the weight of the load to be attached.

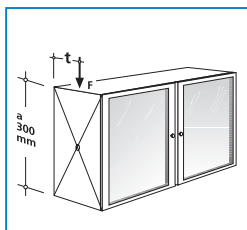

Rated dowel load-bearing capacity

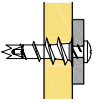
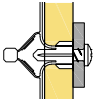
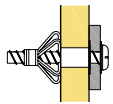
Panelling and panel thickness	Dowel load-bearing capacity	
	single-layer Rigidur H 12,5	double-layer Rigidur H 12,5
Gypsum board dowels 	37 kg	37 kg
Plastic cavity dowels 	60 kg	60 kg
Metal cavity dowels 	87 kg	115 kg

The rated values were calculated on the basis of characteristic values (calculation in accordance with DIN EN 1990 Annex D7.2) including a safety factor of 1.3. The values apply exclusively at climatic conditions of around 20 °C and ≤ 65% humidity.

Permitted vertical loads on screws

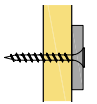
Panelling and Board thickness	Coarse thread screws ¹⁾ (chipboard screw, diameter: 4-5 mm)	
	single-layer Rigidur H 12.5	double-layer Rigidur H 12.5
Threaded screws 	30 kg	60 kg

¹⁾ Standard fully threaded screws (without a shaft) should be used to ensure secure attachment.

! Note

The regulations set out in DIN 18183-1 must be observed.

Heavy bracket loads

- Heavy bracket loads should be fastened to the substructure. Sanitary elements should generally be fastened to separate mounts or traverses.
- Where wall panelling is attached straight onto solid substrates (e.g. drylining), bracket loads should be anchored directly to the solid component using suitable fasteners.

14.2 Loads on ceilings

Installations such as lights, etc. can be attached anywhere on Rigidur ceilings. Cavity dowels for ceiling structures or special tilting dowels and spring toggle bolts made of metal are available for this purpose.

Fastening of loads to ceiling panelling using special, load-bearing ceiling substructures

Panelling	Tilting dowels or spring toggle bolts
Rigidur H 10	10 kg
Rigidur H 12.5	15 kg
Rigidur H 10 + 12.5	20 kg

! Notes

The expected loads must be taken into account in the substructure. Special conditions apply for fire protection requirements.

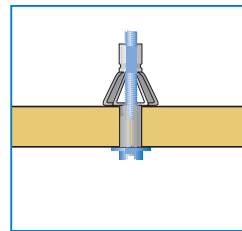

Cavity dowel, e.g. Molly screw anchor or Hilti HDD cavity anchor

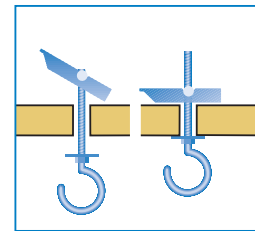

Tilting dowels

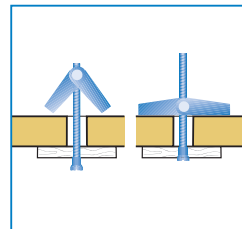

Spring toggle bolts

© Saint-Gobain Rigips GmbH

1st edition, July 2021

The information given in this document corresponds to the following: State of our knowledge and experience at Printing (cf. Printing endorsement). Unless expressly agreed otherwise, however, they do not constitute a guarantee in the legal sense. The state of knowledge and experience is constantly evolving.

Therefore, please make sure to use the latest edition of this publication (**www.rigidur.com**).

The described product applications cannot take into account special circumstances of the individual case. Therefore, check our products for their suitability for the specific purpose of application. If you have any questions, please contact your partners in place of production.

Headquarters

Saint-Gobain Rigips GmbH

Schanzenstraße 84
40549 Duesseldorf
Germany

Climafit®, Die Dicke von Rigips®, Rifino®, Rifix®, Rigidur®, RigiProfil®, Rigips®, RigipsProfi®, RigiRaum®, RigiSystem®, RigiTherm®, Rigitone®, Rikombi®, Rimat®, RiStuck® and VARIO® are registered brands of Saint-Gobain Rigips GmbH. Activ'Air®, AquaBead®, Aquaroc®, Glasroc®, Gyptone®, Habito® and Levelline® are registered brands of Compagnie de Saint-Gobain.

rigidur.com



Headquarters
Saint-Gobain Rigips GmbH
Schanzenstraße 84
40549 Duesseldorf
Germany
Phone +49(0)211 5503-0
Fax +49(0)211 5503-208
info@rigips.de
www.rigips.de